

Addison Nightstands

Duet finish

Assembly Instructions

Model #

1115DUETc Small 3-Drawer Addison Nightstand

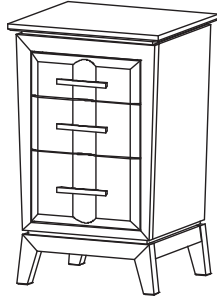

1116DUETc 3-Drawer Addison Nightstand

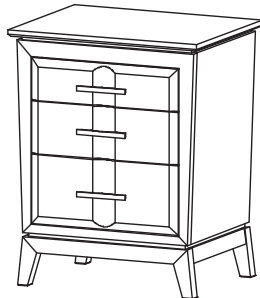

Thank you for allowing us to help you furnish your home. We are certain you will be delighted with your new furniture for many years to come.

IMPORTANT NOTES:

- Wood can be susceptible to changing color over time when exposed to strong sunlight. Use window shades, drapes or blinds to protect your furniture. To help the surface age evenly and avoid dark and light spots, periodically move items to expose the entire surface to an even amount of light so it may develop a uniform patina.
- For normal household use only. *Not* recommended for commercial use.
- Do not climb, sit or stand on this piece of furniture.
- Do not overload the drawers.
- Unload items before you move this unit.

WARNING

Drilling, sawing, sanding or machining wood products can expose you to wood dust, a substance known to the state of California to cause cancer. Avoid inhaling wood dust or use a dust mask or other safeguards for personal protection.

For more information go to: www.p65warnings.ca.gov/wood

This product can expose you to chemicals, including formaldehyde, which are known to the State of California to cause cancer.

For more information go to: www.p65warnings.ca.gov/furniture

DESIGN SUBJECT TO CHANGE WITHOUT NOTICE.

CUSTOMER SERVICE

If you ever have questions about your furniture, please do not hesitate to contact us. In the unlikely event you need a replacement part; we can make those parts available through an authorized Whittier Wood Furniture dealer. If you cannot order replacement parts through your dealer, please contact our customer service department.

Hours: Our friendly customer service staff can be reached:

Monday-Friday 8:00 a.m. to 5:00 p.m. (Pacific Time).

You may leave a message 24 hours a day, seven days a week.

Customer Service: 800-653-3336 • **Outside the U.S.:** 541-687-0213

Fax: 541-687-2060 • **Email:** info@whittierwood.com

**Whittier
Wood**
FURNITURE

P.O. Box 2827
Eugene, OR 97402 USA











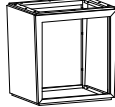





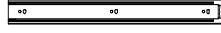

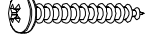
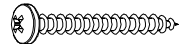
Production Code:

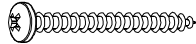
VN

08/18

1115DUETc Small 3-Drawer Addison Nightstand
1116DUETc 3-Drawer Addison Nightstand
Parts List

Please identify the parts and check that quantities received match those on this list.
 If you need to replace a part, refer to the following letter and part name.

Part	Description		Quantity	
			1115DUETc	1116DUETc
Ab	Top Assembly (attached)		1	1
Bc	Case		1	1
C	Small Drawer Box (inserted)		1	1
D	Medium Drawer Box (inserted)		1	1
E	Large Drawer Box (inserted)		1	1
F	Small Drawer Face (installed)		1	1
G	Medium Drawer Face (installed)		1	1
H	Large Drawer Face (installed)		1	1
I	Drawer Slides (pre-installed sets)		3	3
J	#6 x 3/4" Philtruss Screw (inserted)		18	18
K	#6 x 1/2" Philtruss Screw (inserted)		18	18
M	#8 x 1" Pan Head Screw (inserted)		6	6
N	#8 x 1-1/4" Pan Head Screw (inserted)		6	6
O	#8 x 7/8" Black Lo-Profile Screw (inserted)		21	21
P	#8 x 1-3/4" Pan Head Screw (inserted)		8	8
Q	#8 x 1-5/8" Machine Screw Tuscan (installed)		6	6
S	1/4" x 20mm Insert Nut (inserted)		4	4
T	5/32" x 10mm Insert Nut (inserted)		6	6
U	Black Walnut Pull (attached)		3	3
V	Small Adjustable Glide (installed)		4	4
W	Base (attached)		1	1
X	#8 x 1-5/8" Black Screw (inserted)		8	8
ZA	#8 x 1-3/8" Lo-Profile Screw (inserted)		10	12

1116 shown in the illustrations.

1115DUETc Small 3-Drawer Addison Nightstand
1116DUETc 3-Drawer Addison Nightstand
Assembly Instructions

Tool Required: Phillips Screwdriver

1. Remove screws from the plywood supports and side aprons. Recycle or discard. See Figure 1.

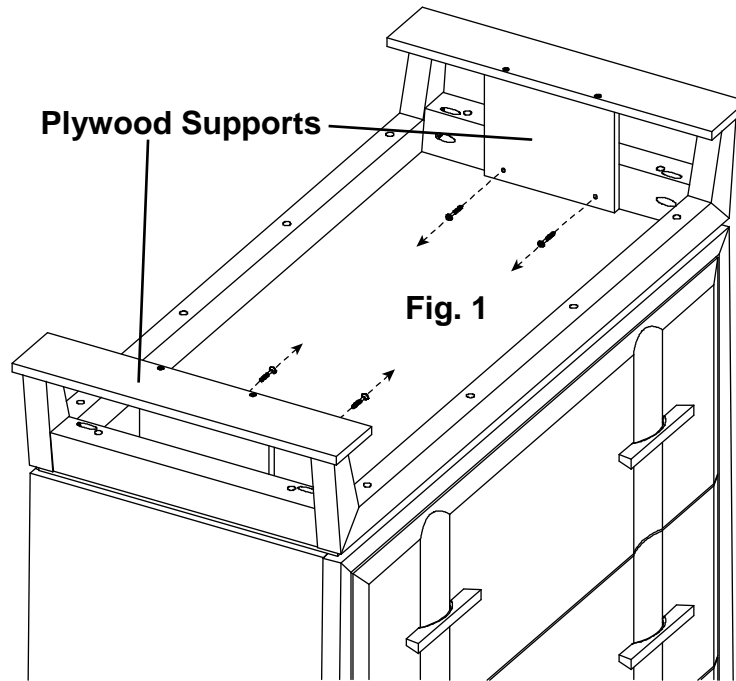

Fig. 1

2. Place the unit at its final destination. Rotate the Small Adjustable Glides (V) on the bottoms of the legs until the unit is level. See Figure 2.

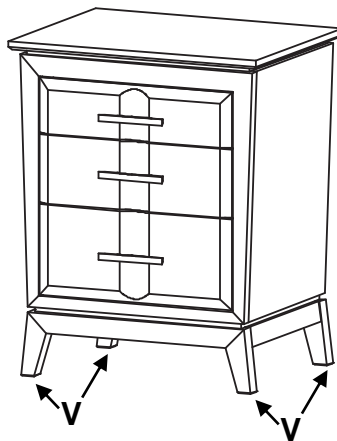

Fig. 2