

Model #

1122GACa;

1122CAFa

McKenzie

2-Drawer Bench

GAC = Glazed Antique Cherry finish

CAF = Caffè finish

Assembly Instructions

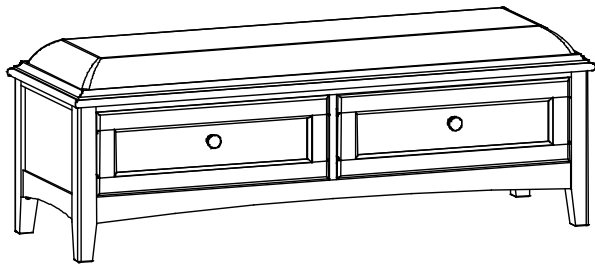

Thank you for allowing us to help you furnish your home. We are certain you will be delighted with your new furniture for many years to come.

IMPORTANT NOTES:

- For normal household use only. *Not* recommended for commercial use.
- Do not climb or stand on or in this piece of furniture.
- Do not overload the drawers.
- Unload items before you move this unit.
- This assembly requires two people.

WARNING

Drilling, sawing, sanding or machining wood products can expose you to wood dust, a substance known to the state of California to cause cancer. Avoid inhaling wood dust or use a dust mask or other safeguards for personal protection.

For more information go to: www.p65warnings.ca.gov/wood

This product can expose you to chemicals, including formaldehyde, which are known to the State of California to cause cancer.

For more information go to: www.p65warnings.ca.gov/furniture

DESIGN SUBJECT TO CHANGE WITHOUT NOTICE.

CUSTOMER SERVICE

If you ever have questions about your furniture, please do not hesitate to contact us. In the unlikely event you need a replacement part; we can make those parts available through an authorized Whittier Wood Furniture dealer. If you cannot order replacement parts through your dealer, please contact our customer service department.

Hours: Our friendly customer service staff can be reached:

Monday-Friday 8:00 a.m. to 5:00 p.m. (Pacific Time).

You may leave a message 24 hours a day, seven days a week.

Customer Service: 800-653-3336 • **Outside the U.S.:** 541-687-0213

Fax: 541-687-2060 • **Email:** info@whittierwood.com

**Whittier
Wood**
FURNITURE

P.O. Box 2827
Eugene, OR 97402 USA

Production Code:











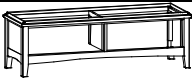

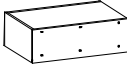
VN

02/17

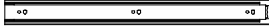
1122GACa; 1122CAFa McKenzie 2-Drawer Bench

Parts List

Please identify the parts and check that quantities received match those on this list.
If you need to replace a part, refer to the following letter(s) and part name.

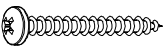
Part	Description		Quantity
A	Case Assembly		1
B	Upholstered Seat		1
C	Drawer Box (inserted)		2
D	Drawer Face (installed)		2
E	Knob (attached)		2
Fa	#8 x 1-1/2" Machine Screw Tuscan (installed)		2
G	14" Drawer Slides (pre-installed sets)		2
H	#6 x 1/2" Philtruss Screw (inserted)		12
I	#6 x 3/4" Philtruss Screw (inserted)		12
J	Insert Nut (inserted)		4
K	Adjustable Glide (installed)		4
La	#8 x 7/8" Black Lo-Profile Screw (inserted)		12
M	#8 x 1-1/4" Pan Head Screw		7 (1 inserted)

1122GACa; 1122CAFa McKenzie 2-Drawer Bench

Assembly Instructions

Tool Required: Phillips Screwdriver

1. This unit was shipped with the seat placed into its recessed position but not attached with screws. This allows for easy removal if you wish to customize the upholstery on your seat. To reupholster the seat we suggest you seek professional advice.

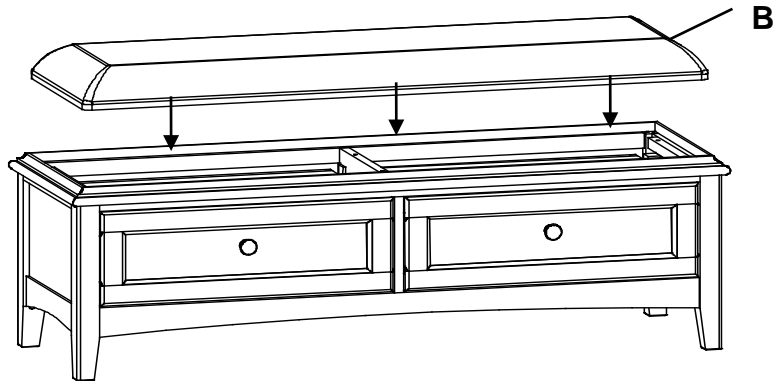
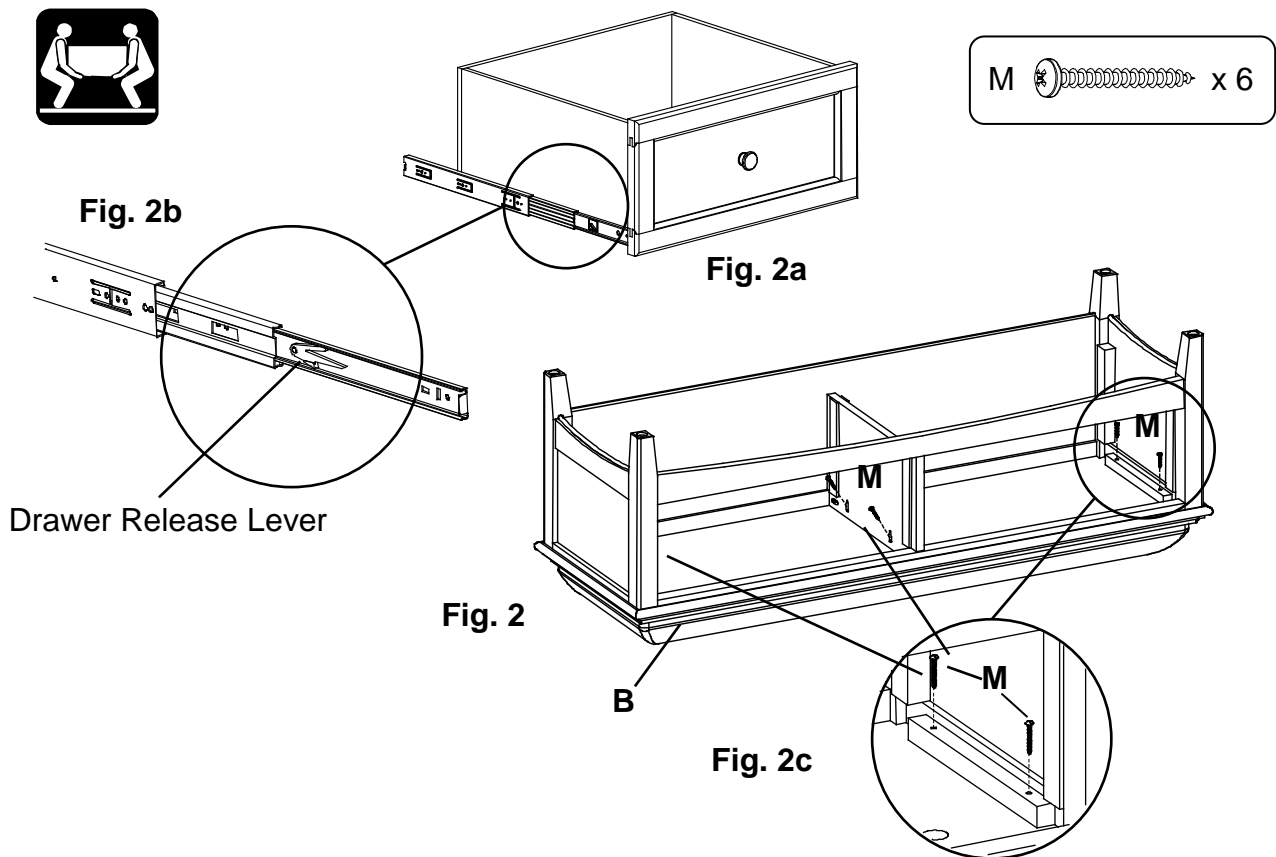

Fig. 1

2. To attach your seat, remove the drawers, noting where each drawer came from to ensure correct reinstallation. To remove the drawers, push up on the left Drawer Release Lever while pushing down on the right Drawer Release Lever (see Figures 2a and 2b). Place the unit upside down. Using the predrilled holes as guides, attach the Seat (B) with the six #8 x 1-1/4" Pan Head screws (M) as shown in Figures 2 and 2c. Turn the unit upright and install the drawers.



1122GACa; 1122CAFa McKenzie 2-Drawer Bench

Assembly Instructions

3. Place the bench at its final destination. Rotate the Adjustable Glides (K) on the bottoms of the legs until the unit is level. See Figure 3.

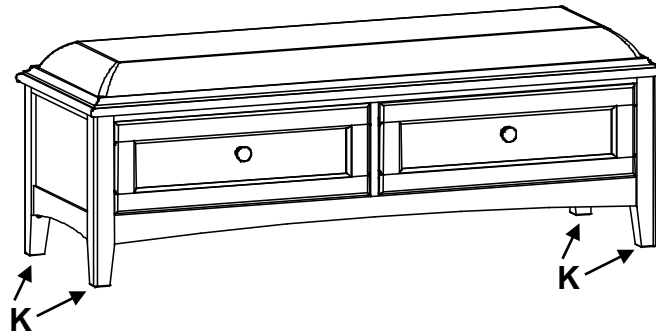

Fig. 3

Please note: Our upholstered seat is covered in Bonded Leather. To clean it, simply use a soft cloth, mild soap and water. DO NOT use alcohol based cleaning agents.