

# McKenzie Sound Bar Media Consoles

GAC = Glazed Antique Cherry finish

CAF = Caffè finish

Assembly Instructions

Model #

**2081GAC**

**2081CAF**

54"W McKenzie  
Sound Bar Media  
Console

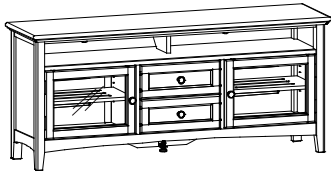
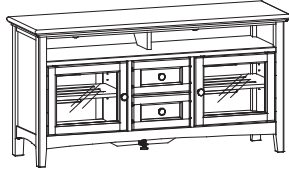

**2082GAC**

**2082CAF**

64"W McKenzie  
Sound Bar Media  
Console

**2083GAC**

**2083CAF**

74"W McKenzie  
Sound Bar Media  
Console

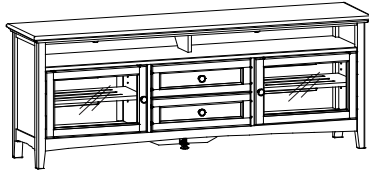

*Thank you for allowing us to help you furnish your home. We are certain you will be delighted with your new furniture for many years to come.*

## IMPORTANT NOTES:

- For normal household use only. *Not* recommended for commercial use.
- Do not climb, sit or stand on this piece of furniture.
- Do not overload the drawers or shelves.
- Unload items before you move this unit.



- Handle the glass plates with care. Glass is fragile.
- Before you begin your project, completely read the Assembly Instructions.
- This assembly requires two people.

## ⚠ WARNING

Serious or fatal crushing injuries can occur from furniture tip-over. Use of tip-over restraints may only reduce but not eliminate the risk of tip-over.

### To help prevent tip-over:

- Place heaviest items in the bottom drawers.
- Unless specifically designed to accommodate, do not set TVs or other heavy objects on top of this product.
- Never allow children to climb or hang on drawers, doors or shelves.
- Never open more than one drawer at a time.

**Warning:** At least one tipping restraint kit was included with your piece of Whittier Wood Furniture. When you receive your furniture, be sure to find and properly install the tipping restraint(s). If you cannot locate the restraint(s), please contact us immediately for replacement.

Drilling, sawing, sanding or machining wood products can expose you to wood dust, a substance known to the state of California to cause cancer. Avoid inhaling wood dust or use a dust mask or other safeguards for personal protection.

For more information go to: [www.p65warnings.ca.gov/wood](http://www.p65warnings.ca.gov/wood)

This product can expose you to chemicals, including formaldehyde, which are known to the State of California to cause cancer.

For more information go to: [www.p65warnings.ca.gov/furniture](http://www.p65warnings.ca.gov/furniture)

**DESIGN SUBJECT TO CHANGE WITHOUT NOTICE.**

## CUSTOMER SERVICE

If you ever have questions about your furniture, please do not hesitate to contact us. In the unlikely event you need a replacement part; we can make those parts available through an authorized Whittier Wood Furniture dealer. If you cannot order replacement parts through your dealer, please contact our customer service department.

**Hours:** Our friendly customer service staff can be reached:

**Monday-Friday 8:00 a.m. to 5:00 p.m. (Pacific Time).**

You may leave a message 24 hours a day, seven days a week.

**Customer Service: 800-653-3336 • Outside the U.S.: 541-687-0213**

**Fax: 541-687-2060 • Email: [info@whittierwood.com](mailto:info@whittierwood.com)**

**Whittier  
Wood**  
FURNITURE

P.O. Box 2827  
Eugene, OR 97402 USA

Production Code:











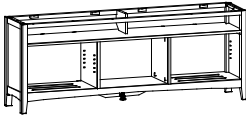
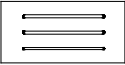

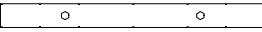
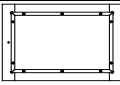
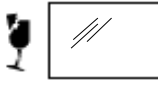

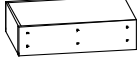

VN

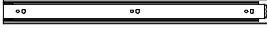
05/17

**2081GAC 2081CAF 54"W McKenzie Sound Bar Media Console**  
**2082GAC 2082CAF 64"W McKenzie Sound Bar Media Console**  
**2083GAC 2083CAF 74"W McKenzie Sound Bar Media Console**











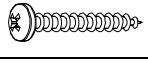
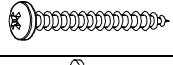

*Parts List*

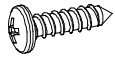
Please identify the parts and check that quantities received match those on this list.  
 If you need to replace a part, refer to the following letter and part name.

Part	Description		Quantity		
			2081GAC 2081CAF	2082GAC 2082CAF	2083GAC 2083CAF
A	Top Assembly (attached)		1	1	1
B	Case		1	1	1
C	Adjustable Shelf (installed)		2	2	2
D	Removable Back (installed)		2	2	2
E	Fitted Back (attached)		1	1	1
F	Door Frame (installed)		2	2	2
G	Door Glass (attached)		2	2	2
H	Wood Door Panel (Optional)		2	2	2
I	Door Glass Support Rail (attached)		4	4	4
J	Door Glass Support Stile (attached)		4	4	4
K	Drawer Box (inserted)		2	2	2
L	Drawer Face (installed)		2	2	2
M	14" Drawer Slides (pre-installed sets)		2	2	2
N	#6 x 5/8" Undercut Screw AB (inserted)		32 (GAC) 8 (CAF)	32 (GAC) 8 (CAF)	32 (GAC) 8 (CAF)
O	#6 x 5/8" Undercut Screw ZN (inserted)		0 (GAC) 24 (CAF)	0 (GAC) 24 (CAF)	0 (GAC) 24 (CAF)
P	#6 x 3/4" Philtruss Screw (inserted)		12	12	12
Q	#6 x 1/2" Undercut Screw AB (inserted)		8	8	8
R	#6 x 3/4" Flat Head Screw (inserted)		16	20	20
S	#6 x 1/2" Philtruss Screw (inserted)		12	12	12
T	#6 x 5/8" Philtruss Screw (inserted)		30	34	34

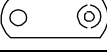
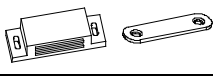
**2081GAC 2081CAF 54"W McKenzie Sound Bar Media Console**  
**2082GAC 2082CAF 64"W McKenzie Sound Bar Media Console**  
**2083GAC 2083CAF 74"W McKenzie Sound Bar Media Console**

*Parts List*

Part	Description	Quantity		
		2081GAC 2081CAF	2082GAC 2082CAF	2083GAC 2083CAF
U	#8 x 1-3/8" Lo-Profile Screw (inserted) 	8	10	10
V	#8 x 1" Pan Head Screw (inserted) 	4	4	4
W	#8 x 1-1/4" Pan Head Screw (inserted) 	14	15	15
X	#8 x 7/8" Black Lo-Profile Screw (inserted) 	8	8	8
Y	#8 x 1-1/4" Black Screw (inserted) 	5	6	6
ZA	#8 x 1-1/2" Machine Screw Tuscan (installed) 	4	4	4
ZB	#10 x 3/4" Pan Head Screw (inserted) 	4	4	4
ZC	Hinge (attached) 	4	4	4
ZD	Drawer Stop (attached) 	4	4	4
ZE	Insert Nut (inserted) 	4	4	4
ZF	Knob (attached) 	4	4	4
ZG	Turn Button (attached) 	4	4	4
ZH	Tuscan Magnetic Lock & Plate (pre-installed sets) 	4	4	4
ZI	Foot Bracket (attached) 	1	1	1
ZJ	Adjustable Glide (installed) 	1	1	1
ZK	Small Adjustable Glide (installed) 	4	4	4
ZL	Shelf Bracket (installed) 	8	8	8
TS	Media Tipping Restraint (attached)	1 set	1 set	1 set

*2083 shown in the illustrations.*

2081GAC 2081CAF 54"W McKenzie Sound Bar Media Console  
 2082GAC 2082CAF 64"W McKenzie Sound Bar Media Console  
 2083GAC 2083CAF 74"W McKenzie Sound Bar Media Console  
 Assembly Instructions

Tools Required: Phillips Screwdriver, Pencil.

- Place the console at its final destination. Rotate the Adjustable Glides (ZK) found at the corners of the unit and (ZJ) at the bottom of the Center Foot until the unit is level. See Figure 1.

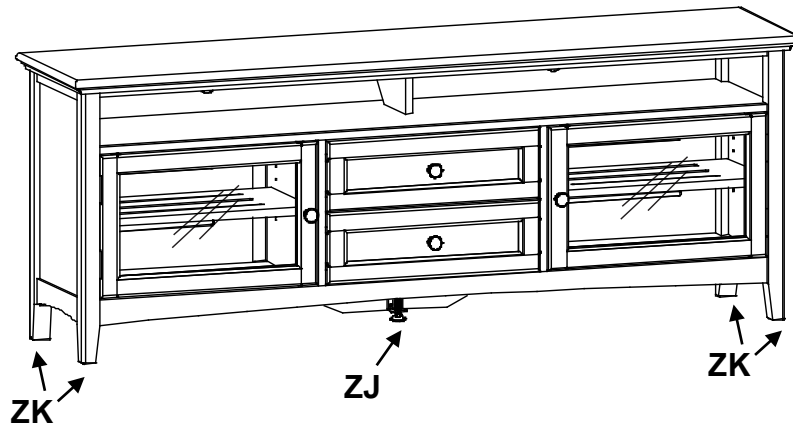
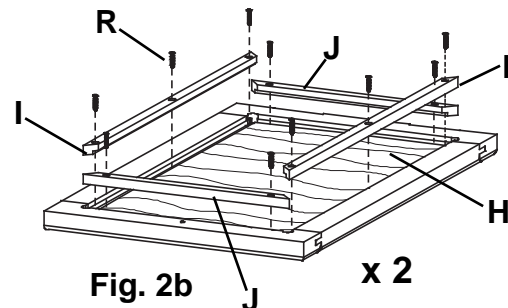
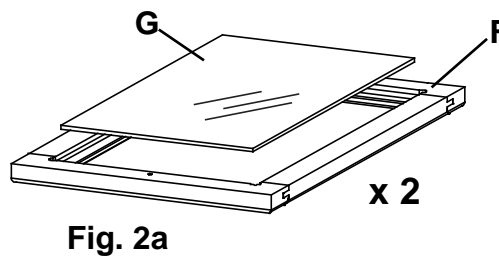
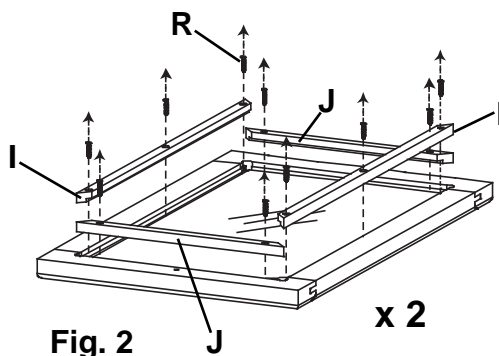
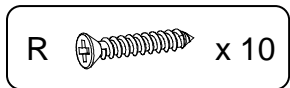

Fig. 1

- Two Wood Door Panels (H) have been included as an optional replacement for the Door Glass (G). To install the optional Wood Door Panels (H), remove the doors from the unit and place them face down on a clean, protected surface. **DO NOT LEAN ON THE GLASS AT ANY TIME.** Remove the screws from the Door Glass Support Rails (I) and Door Glass Support Stiles (J) and carefully remove Door Glass (G). See Figures 2 and 2a. Place the good face of the Wood Door Panels (H) within the Door Frames (F) face down and reattach the Rails and Stiles with the #6 x 3/4" Flat Head Screws (R). See Figure 2b. Reattach Doors to the Media Console. See Figures 2, 2a, 2b.



**2081GAC 2081CAF 54"W McKenzie Sound Bar Media Console**  
**2082GAC 2082CAF 64"W McKenzie Sound Bar Media Console**  
**2083GAC 2083CAF 74"W McKenzie Sound Bar Media Console**  
*Assembly Instructions*

---

3. To insert your media components and access wires more easily, you may want to remove the Removable Backs (D). To do so, unlock the Turn Buttons (ZG) as shown in Figures 3 and 3b. Slide the Backs away and place them off to the side. After installing the components, slide the Backs (D) behind the Drawer Stops (ZD) and lock the Turn Buttons. See Figures 3, 3a, 3b, 3c.

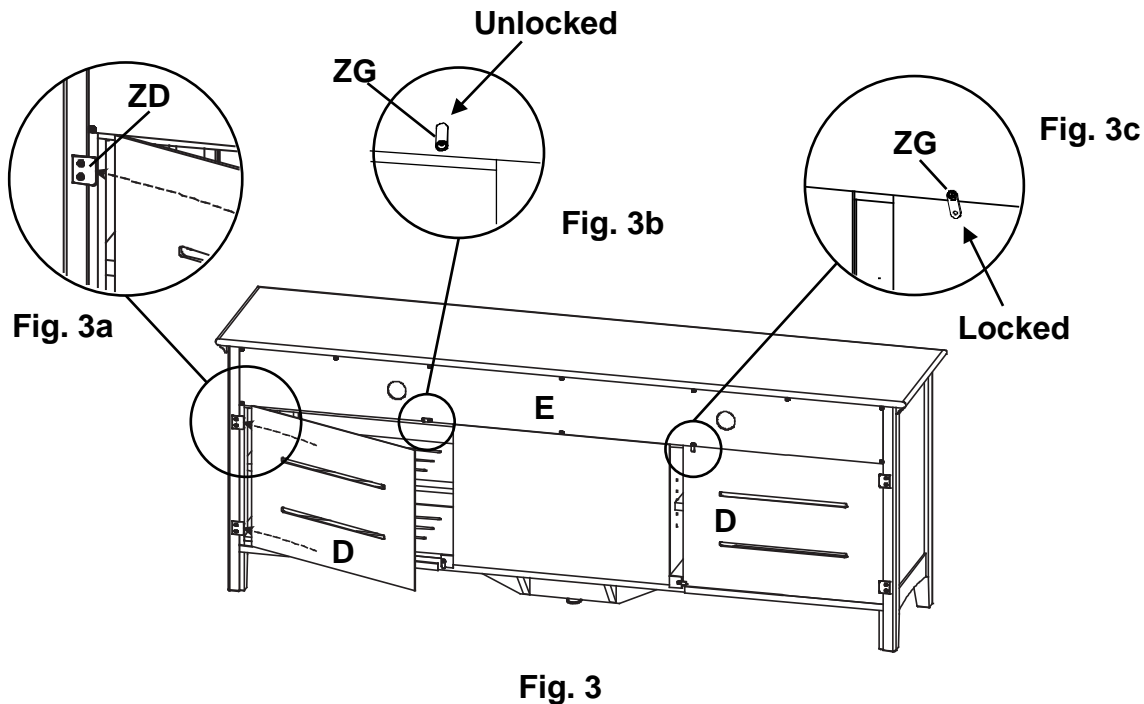

4. To move the Adjustable Shelves (C), remove the #6 x 1/2" Undercut Screws (Q) and the Shelves (C). Reposition the Shelf Brackets (ZL) to the desired positions, replace the shelf and insert the screws. See Figures 4 and 4a.

*Door removed for illustration purposes.*

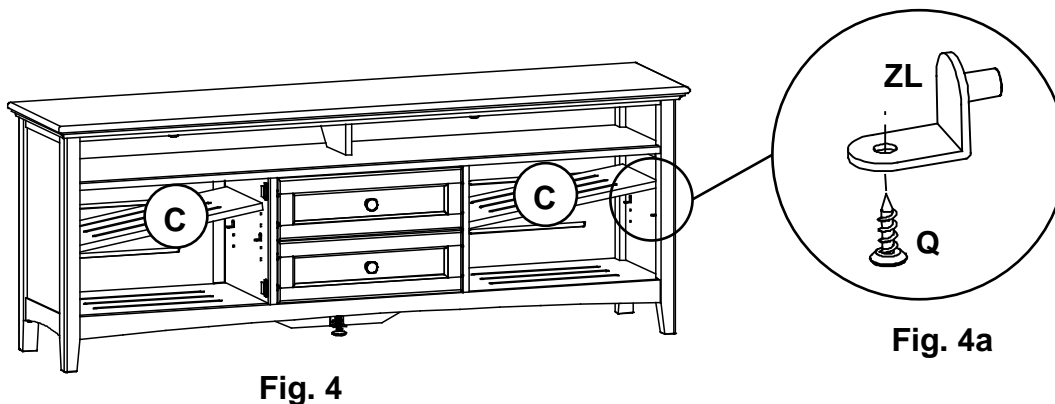





**2081GAC 2081CAF 54"W McKenzie Sound Bar Media Console**  
**2082GAC 2082CAF 64"W McKenzie Sound Bar Media Console**  
**2083GAC 2083CAF 74"W McKenzie Sound Bar Media Console**

*Assembly Instructions*

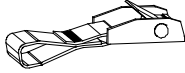
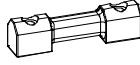
## Furniture Tipping Restraint Instructions

Before you begin this assembly, identify each part and make sure the quantities received match what is on this list. If you need to replace a part, contact Whittier Wood Furniture customer service and refer to the following list for its name and letter code.

Part	Description		Quantity
A	Cam Buckle and Short Strap (installed)		1
B	Plastic Bracket (installed)		1
C	1" x 1000mm Long Strap (installed)		1
D	#8 x 3" Pan Head Screw		2
E	#10 x 1" Oval Head Screw (inserted)		1
F	Washer		1

**If you have a stone or tile floor or do not wish to drive screws into the corner of the baseboard and floor see the instruction included inside the tipping restraint kit for an alternate installation.**

- Decide where you want to place the piece of furniture in your room. Mark the baseboard with a pencil mark directly behind the location where the tipping restraint is attached to your item. Move the item away from the wall far enough to allow you to access the spot where the baseboard meets the floor. Position the straps and Plastic Bracket (B) as shown in Figures 5 and 5a with the angled corners of the Plastic Bracket (B) firmly placed against the seam of the baseboard and floor. Attach by driving #8 x 3" Pan Head Screws (D) through the holes in the Plastic Bracket (B) into the seam below the baseboard where it meets the floor. See Figures 5 and 5a.

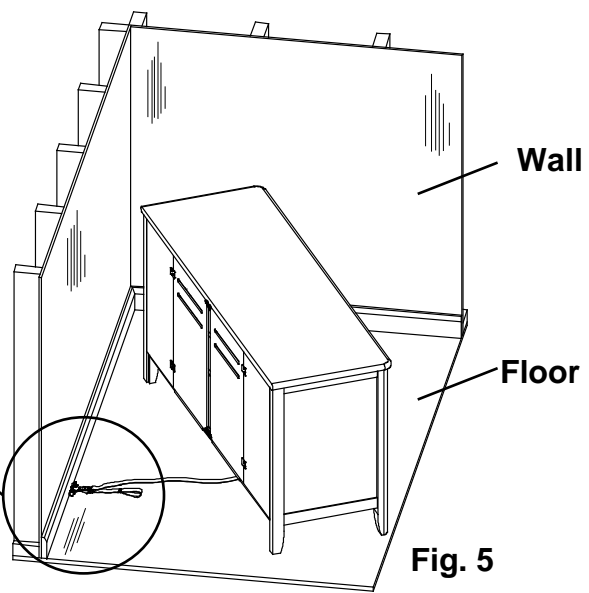
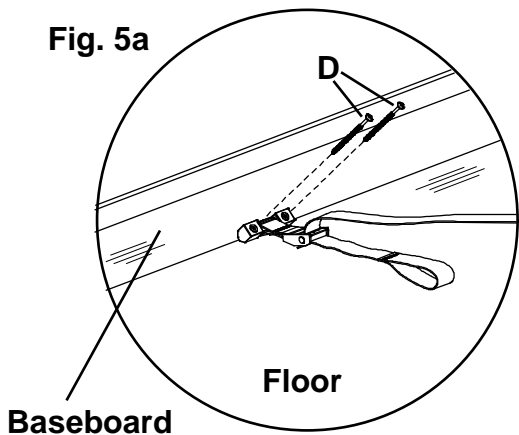
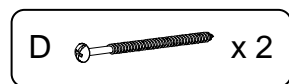

**2081GAC 2081CAF 54"W McKenzie Sound Bar Media Console**  
**2082GAC 2082CAF 64"W McKenzie Sound Bar Media Console**  
**2083GAC 2083CAF 74"W McKenzie Sound Bar Media Console**  
*Assembly Instructions*

---

6. Move the item back into position against the wall and reach underneath the piece of furniture to grasp the loop in the free end of the strap. Pull the free end of the strap until portion between the Cam Buckle (A) and the back apron of the item is tight. See Figures 6 and 6a. If you need to move the piece of furniture reach beneath and locate the buckle which connects the two sections of the strap and depress the release lever, then pull on the section of strap that is between the buckle and the back apron of the furniture until there is enough slack to allow you to pull the item away from the wall.

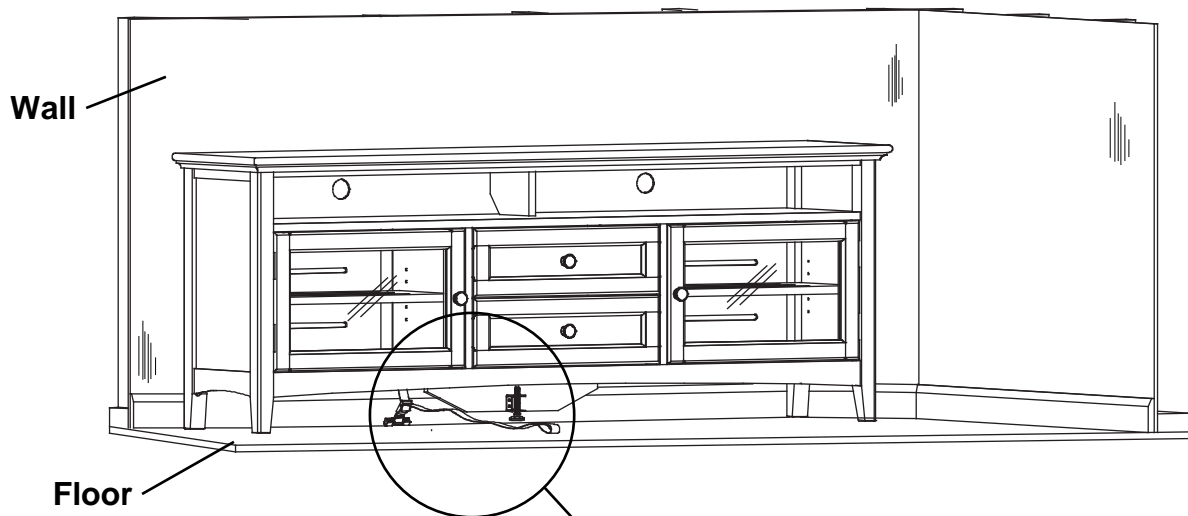

**Fig. 6**

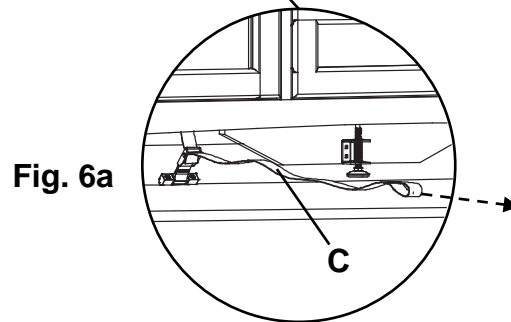

**Fig. 6a**