

Model #

# 2402AFGACd; 2402AFCAFd

## McKenzie File Cabinet

AFGAC = Glazed Antique Cherry finish

AFCAF = Caffè finish

Assembly Instructions



### Congratulations!

*This fine piece of furniture will make a gorgeous addition to your home. For the best results, read the Assembly Instructions before you begin your project.*

### IMPORTANT NOTES:

- For normal household use only. *Not* recommended for commercial use.
- Use a protective pad when you use the top of this piece as a writing surface.
- Do not climb, sit or stand on this piece of furniture.
- Do not overload the drawers.
- Unload items before you move this unit.
- Before you load or move this unit, tighten all screws and supports.
- Before you begin your project, completely read the Assembly Instructions.
- Store this item: 1- in its box; 2- in a dry place; 3- in temperatures that range from 40°F to 90°F (not on a cold and possibly damp cement floor).
- Periodically inspect your furniture for any loose glue joints, screws or any other problem that might affect the stability of your furniture. Tighten or repair as needed.

### WARNING

#### Notice to California Customers

California Prop 65 requires consumer goods to be labeled if any one of 850+ different chemicals or substances, including wood dust, is present even in trace amounts. Drilling, sawing, sanding or machining wood products generates wood dust, a substance known to the State of California to cause cancer. **Warning:** This product contains a chemical or substance known to the State of California to cause cancer, birth defects or other reproductive harm. *California Health and Safety Code Section 25249.6*

**DESIGN SUBJECT TO CHANGE WITHOUT NOTICE.**

 **CALL US FIRST!** *Do not return this item to the store*

**Service Policy:** We will replace any part that is defective, missing or damaged during assembly. For a replacement part, directly contact Whittier Wood Products customer service department by phone, fax, mail or email.

**Hours:** Our friendly customer service staff can be reached Monday-Friday 7:00 a.m. to 5:00 p.m. (Pacific Time). You may leave a message 24 hours a day, seven days a week.

**To Order:** Provide the finish and furniture model number (upper portion of this page), the part letter, production code, quantity needed, reason for replacement and your full name, address and telephone number.

*Parts ship from our Eugene, Oregon factory within one or two business days from the time we receive your request. Please allow five to ten business days for delivery.*

800-653-3336 • Outside the U.S. or Canada: 541-687-0213 • Fax: 541-687-2060  
www.whittierwood.com • P.O. Box 2827 • Eugene, Oregon 97402, U.S.A.



P.O. Box 2827  
Eugene, OR 97402 USA

Production Code:











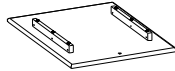





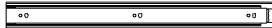

VN

07/14

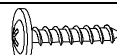
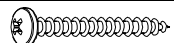
## 2402AFGACd; 2402AFCAFd McKenzie File Cabinet

### Parts List

Please identify the parts and check that quantities received match those on this list.  
If you need to replace a part, refer to the following letter and part name.

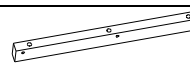
Part	Description		Quantity
Ad	Case Assembly		1
Bd	Top Assembly (attached)		1
C	Lower Drawer (inserted)		1
D	Upper Drawer Face (installed)		1
E	Lower Drawer Face (installed)		1
F	Lock (attached)		1
G	#6 x 5/8" Philtruss Screw (inserted)		2
H	Drawer Slides (pre-installed sets)		2
I	#6 x 3/4" Philtruss Screw (inserted)		20
J	#6 x 1/2" Philtruss Screw (inserted)		16
K	Knob (attached)		2
Lc	#8 x 1-1/2" Machine Screw Tuscan (installed)		2
M	Plastic File Rail (attached)		4
N	Aluminum File Rail		4
Oc	#8 x 7/8" Black Lo-Profile Screw (inserted)		8
P	#8 x 1-1/4" Pan Head Screw (inserted)		8
S	Small Adjustable Glide (installed)		4
T	Upper Drawer (inserted)		1
U	Insert Nut (inserted)		4
V	#8 x 1-3/8" Lo-Profile Screw (inserted)		2
W	#10 x 2" Pan Head Screw (inserted)		6
X	#8 Washer (inserted)		6
Y	Top Support (attached)		2

# 2402AFGACd; 2402AFCAFd McKenzie File Cabinet

## Assembly Instructions

### Tool Required: Phillips Screwdriver

1. Store your letter-sized hanging folders either parallel or perpendicular to the front of the drawer. Legal-sized folders must hang perpendicularly. To hang your files perpendicularly, remove the Plastic File Rails (M). See Figures 1 and 1a. There are slots on the sides of the drawers. Insert an Aluminum File Rail (N) into the slots nearest to the Drawer Face (D or E). Insert another Aluminum File Rail (N) into the second set of notches for letter-sized folders or the third set of notches to hang legal-sized folders. See Figures 1b and 1c.

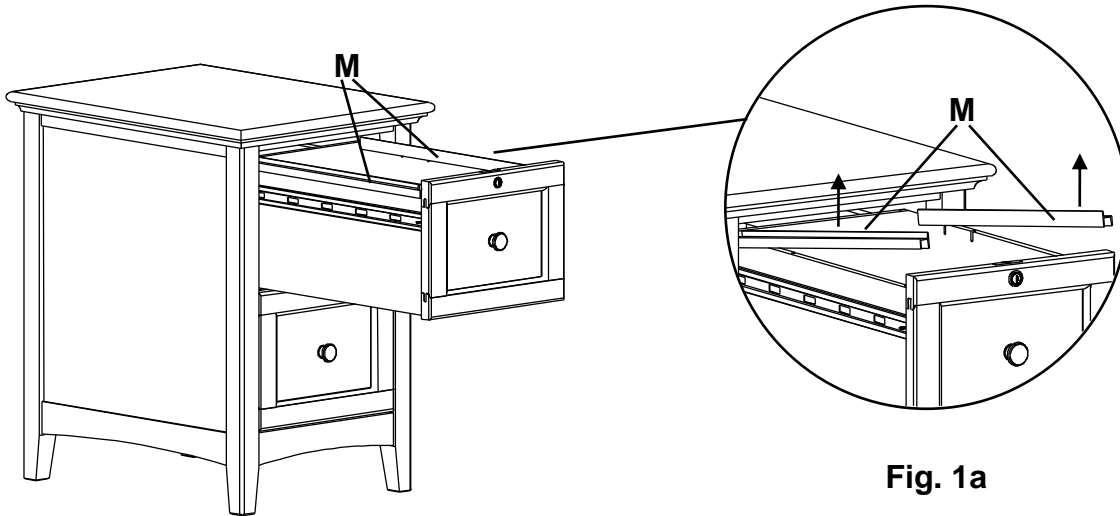

Fig. 1

(For Letter File Size)

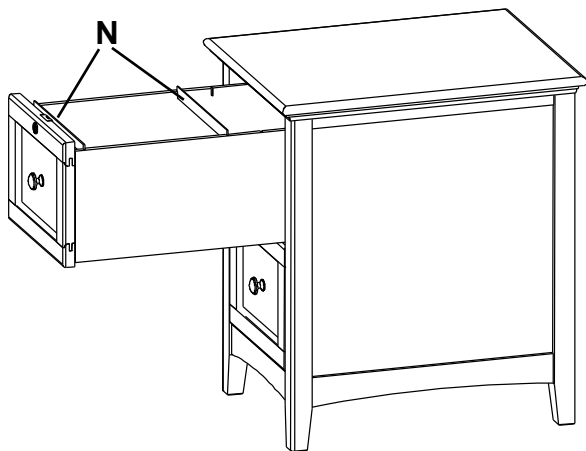

Fig. 1b

(For Legal File Size)

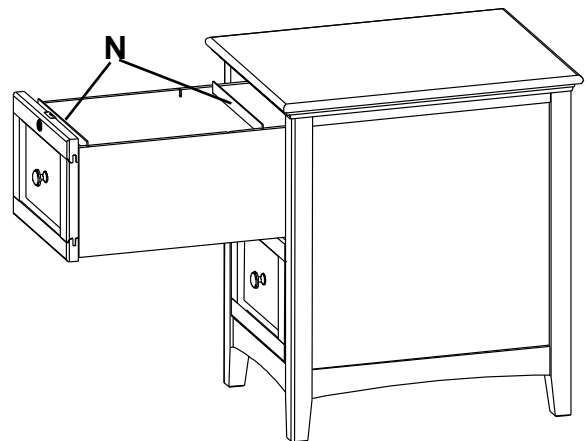

Fig. 1c

## 2402AFGACd; 2402AFCAFd McKenzie File Cabinet

### Assembly Instructions

---

2. Position the unit at the desired location. Adjustable glides (S) are attached to the bottoms of the legs. Rotate the glides until the unit stands level. See Figure 2.

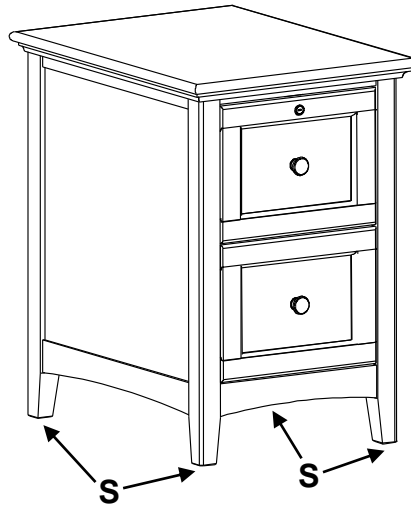

**Fig. 2**

3. Use a protective pad when you use the top of this piece as a writing surface.
4. The keys and the Aluminum File Rails are inside the hardware box.