

ASSEMBLY INSTRUCTIONS

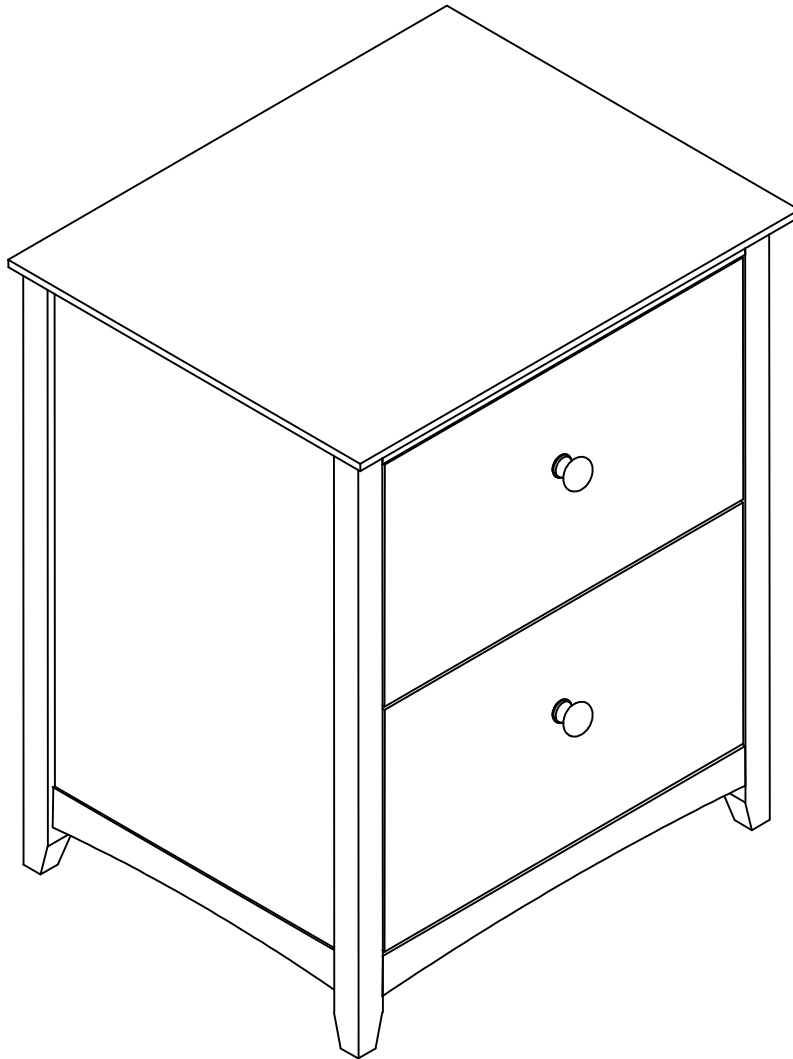

Description : LATERAL FILE CABINET
Item No. : OF-62

BEFORE ASSEMBLY

Thank you for purchasing this quality product. This product has been designed for easy assembly and constructed for durability. All parts were checked prior to packaging to insure quality. Prior to beginning assembly, however, make sure all parts and hardware are included and free of obvious defect. If a part is missing or defective, please contact the store where purchased. If hardware is missing, or you need help with assembly, please call toll free 888-944-8396.

IMPORTANT NOTE:

- Place all wooden parts on a clean and smooth surface such as a rug or carpet to avoid the parts from being scratched.
- Remove all wrapping material, including staples & packing straps before you start to assemble.
- DO NOT tighten all screws and bolts until completely assembled.
- Keep all hardware parts out of reach of children.

WARNING:

Long exposure to rubber or soft plastic may cause a chemical reaction and damage the finish of your table. Protect the surface of the table with cloth if you are using any product with rubber feet or base.

ASSEMBLY TOOLS REQUIRED

NOT INCLUDED





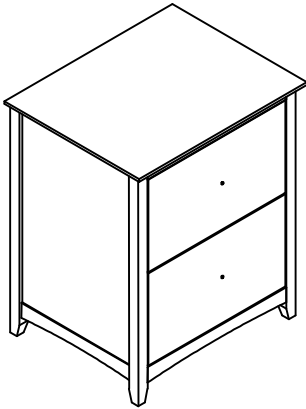

PART LIST

When unpacking, please be careful not to discard any parts with the packaging. Before continuing, please make sure you have the following parts:

NO	Description	Qty	Sketch
A	FILE CABINET	1	

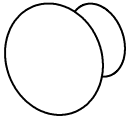
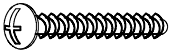
HARDWARE LIST

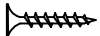
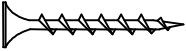
When unpacking, please be careful not to discard any parts with the packaging. Before continuing, please make sure you have all of the following hardware:

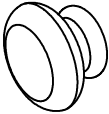
NO	Description	Qty	Sketch	NO	Description	Qty	Sketch
1	Wooden Knob (Φ 30x30mm)	2		2	Pan head screw *Metal knob: (M4x22mm) *Wooden knob: (M4x25mm)	2	
3	Iron bar (Φ 6x512mm)	4		4	Short screw (M3 x 15mm)	2	
5	Long screw (M4x30mm)	1		6	Steel band	1	
7	Warning label	2	<div style="border: 1px solid black; padding: 5px; width: fit-content;"> <p style="text-align: center;">WARNING!</p> <p style="text-align: center;"><small>THIS ITEM IS PRONE TO TIPPING.</small></p> <p style="text-align: center;"><small>USE ANTI-TIPPING HARDWARE (PROVIDED) TO SECURE TO THE WALL.</small></p> <p style="text-align: center;"><small>DO NOT ALLOW CHILDREN TO CLIMB ON FURNITURE.</small></p> <p style="text-align: center;"><small>PLAC HEAVIEST OBJECTS IN LOWER DRAWERS.</small></p> <p style="text-align: center;"><small>DO NOT OPEN MORE THAN ONE DRAWER ON THE UNIT AT THE SAME TIME.</small></p> </div>		METAL KNOB (Φ 35x30mm) GOES WITH FINISHED ITEM ONLY.	2	

STEP 1

Attach Knobs (1) to front of drawers with pan head screws (2). Tighten with a screwdriver.

Insert iron bars (3) into groove (a) or (b) of the drawer as shown below.

Stick the Warning labels (7) inside all drawers before use.

Attach the Steel band (6) to the unit with Short screws (4) and attach the Steel band to the wall with the long screws (5) as shown below. Tighten with a screwdriver (to secure the product and prevent tipping).

