

ASSEMBLY INSTRUCTIONS

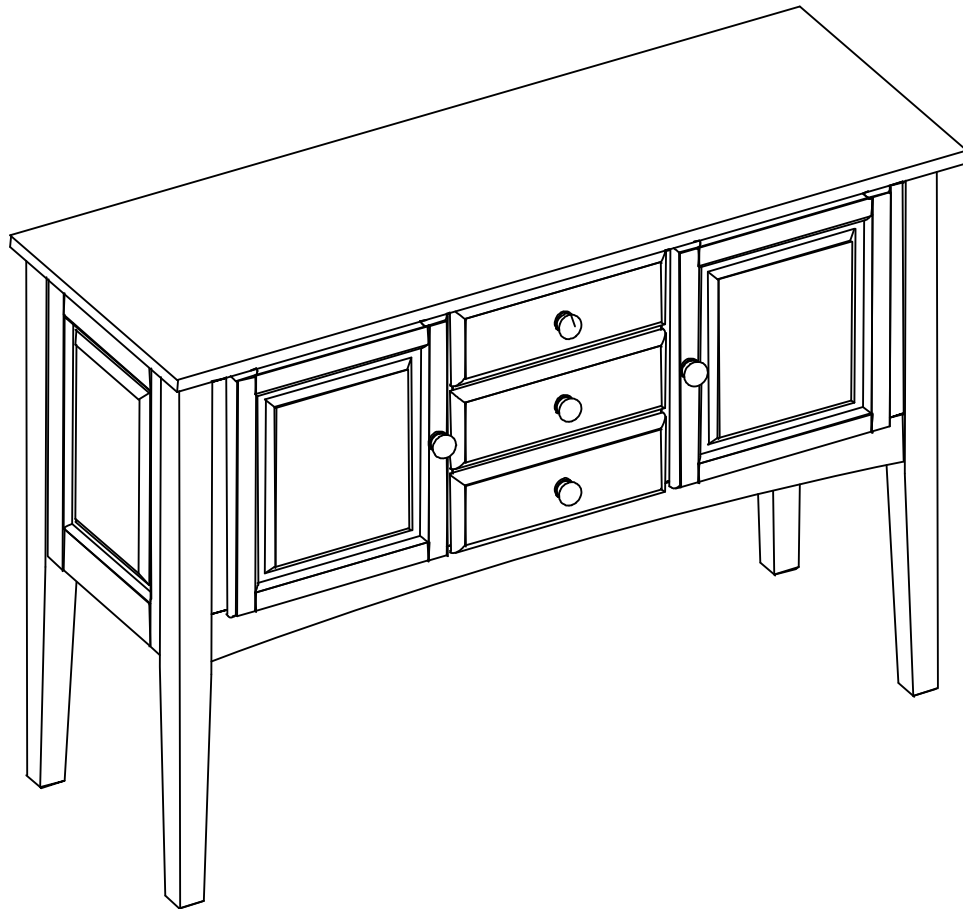

Description : HUNTBOARD SERVER
Item No. : SV-33

BEFORE ASSEMBLY

Thank you for purchasing this quality product. This product has been designed for easy assembly and constructed for durability. All parts were checked prior to packaging to insure quality. Prior to beginning assembly, however, make sure all parts and hardware are included and free of obvious defect. If a part is missing or defective, please contact the store where purchased. If hardware is missing, or you need help with assembly, please call toll free 888-944-8396.

IMPORTANT NOTE:

- Place all wooden parts on a clean and smooth surface such as a rug or carpet to avoid the parts from being scratched.
- Remove all wrapping material, including staples & packing straps before you start to assemble.
- DO NOT tighten all screws and bolts until completely assembled.
- Keep all hardware parts out of reach of children.

WARNING:

Long exposure to rubber or soft plastic may cause a chemical reaction and damage the finish of your product. Protect the surface of the product with cloth if you are using any product with rubber feet or base.







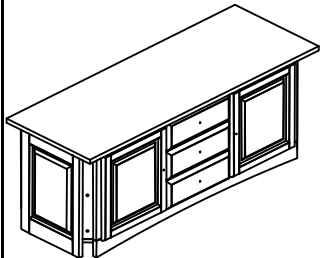
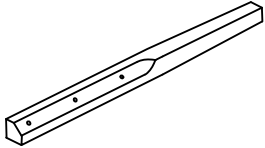

PART LIST

When unpacking, please be careful not to discard any parts with the packaging. Before continuing, please make sure you have the following parts:

NO	Description	Qty	Sketch	NO	Description	Qty	Sketch
A	Server box	01		B	Leg	04	

HARDWARE LIST

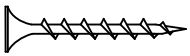
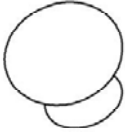
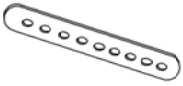
When unpacking, please be careful not to discard any parts with the packaging. Before continuing, please make sure you have all of the following hardware:

NO	Description	Qty	Sketch	NO	Description	Qty	Sketch
1	Bolt (M6x55mm)	12		6	Allen Key (4mm)	1	
2	Lock washer (φ6.5x11mm)	12		7	Short screw (M3.5x15mm)	2	
3	Flat washer (φ6.5x19mm)	12		8	Long screw (M4x30mm)	1	
4	Knob (φ38x30mm)	5		9	Steel band	1	
5	Pan head screw (M4x30mm)	5		10	Warning label	5	<p style="text-align: center;">WARNING! THIS ITEM IS PRONE TO TIPPING.</p> <p>USE ANTI-TIPPING HARDWARE (PROVIDED) TO SECURE TO THE WALL.</p> <p>DO NOT ALLOW CHILDREN TO CLIMB ON FURNITURE.</p> <p>PLACE HEAVIEST OBJECTS IN LOWER DRAWERS.</p> <p>DO NOT OPEN MORE THAN ONE DRAWER ON THE UNIT AT THE SAME TIME.</p> <p>DO NOT PLACE TV ON THE TOP OF THE DRESSER OR DRAWER CHEST.</p>

STEP 1

Attach legs (B) to server box (A) with bolts (1), washers (2) and (3). Tighten with Allen Key (6) as shown below.

Attach knobs (4) to drawers and doors with screws (5). Tighten with a screwdriver.

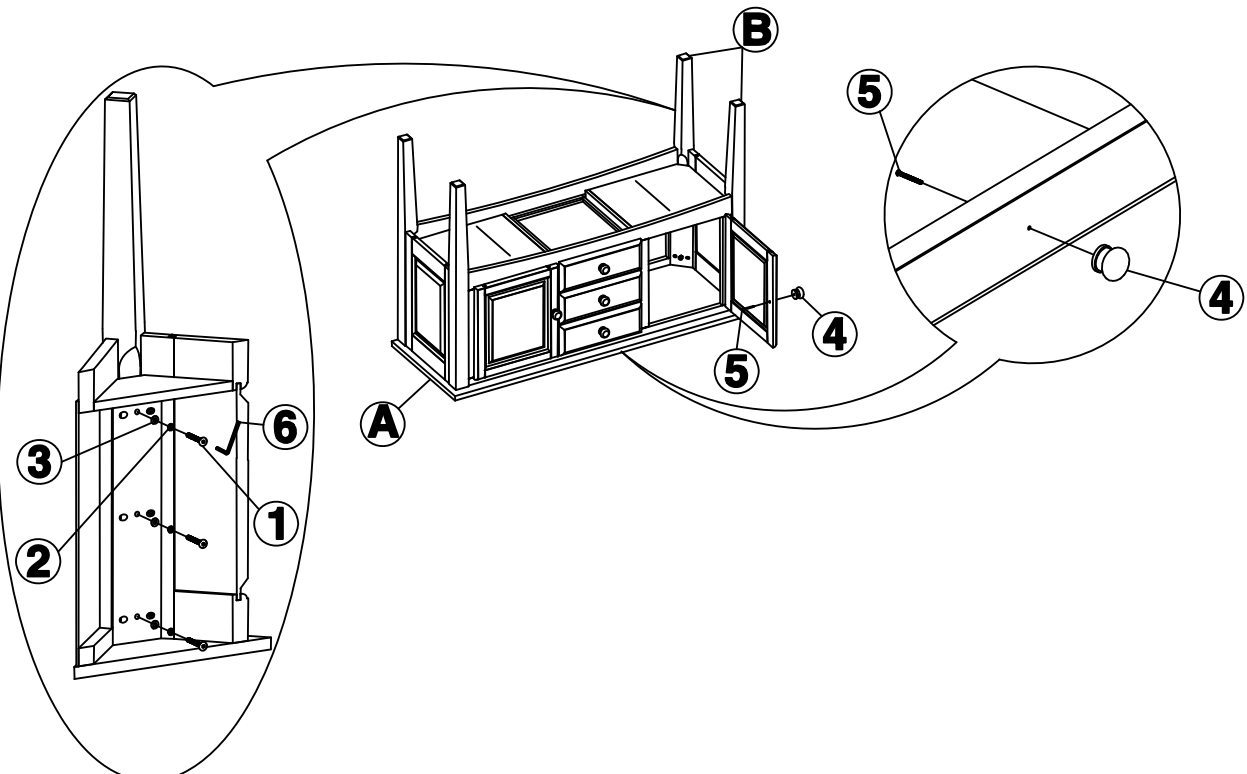

ITEM NO.: SV-33
REVISED DEC 01, 2014

Printed in Vietnam

STEP 2

Attach steel band (9) to the unit with screws (7). Tighten with the screwdriver.
Attach the steel band to the wall with screw (8) as shown below (to secure the product and prevent tipping).

Stick warning labels (10) inside all drawers and at back side of doors before use.

