

ASSEMBLY INSTRUCTIONS

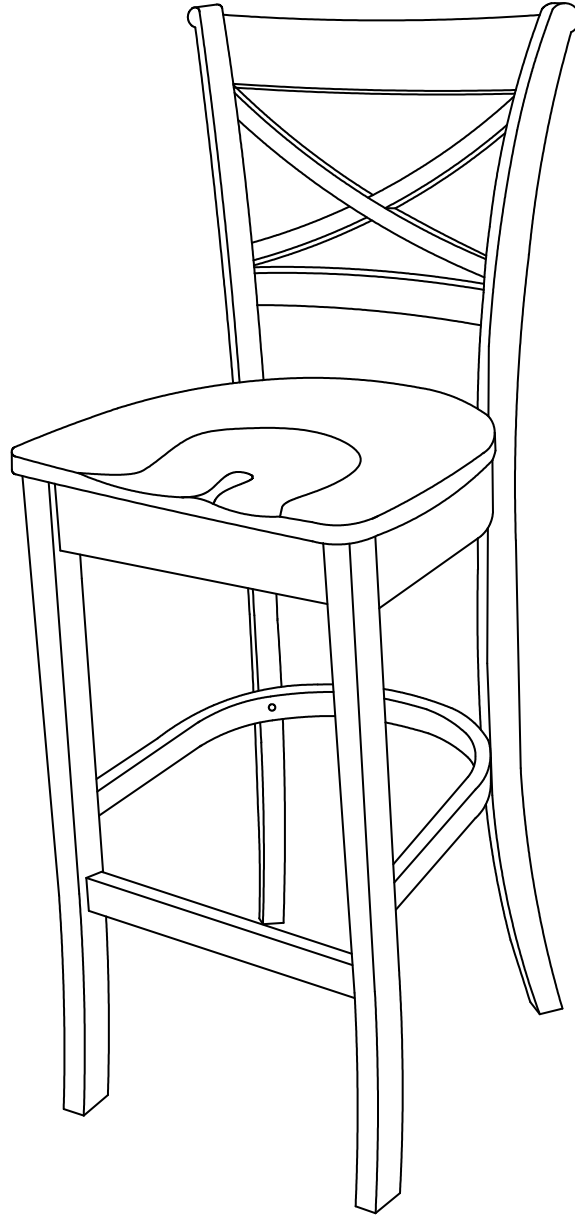

Description	: CHARLOTTE X BACK STOOL 30 IN
Item No.	: S-313

BEFORE ASSEMBLY

Thank you for purchasing this quality product. This product has been designed for easy assembly and constructed for durability. All parts were checked prior to packaging to insure quality. Prior to beginning assembly, however, make sure all parts and hardware are included and free of obvious defect. If a part is missing or defective, please contact the store where purchased. If hardware is missing, or you need help with assembly, please call toll free 888-944-8396.

IMPORTANT NOTE:



- Place all wooden parts on a clean and smooth surface such as a rug or carpet to avoid the parts from being scratched.
- Remove all wrapping material, including staples & packing straps before you start to assemble.
- DO NOT tighten all screws and bolts until completely assembled.
- Keep all hardware parts out of reach of children.

ASSEMBLY TOOLS REQUIRED NOT INCLUDED





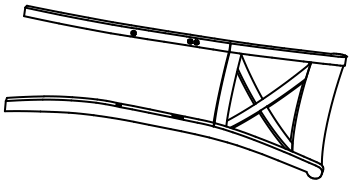
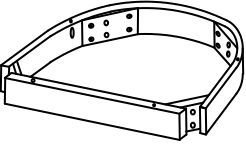
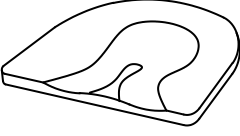
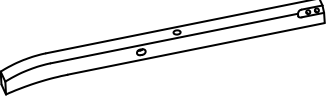
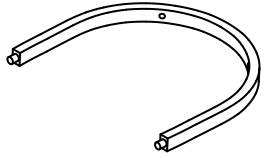

PART LIST

When unpacking, please be careful not to discard any parts with the packaging. Before continuing, please make sure you have the following parts:

NO	Description	Qty	Sketch	NO	Description	Qty	Sketch
A	Chair back	1		B	Seat Frame	1	
C	Chair Seat	1		D	Front Leg (L-R)	2	
E	Side Stretcher	1		F	Front Stretcher	1	

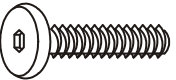
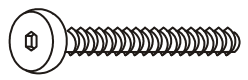
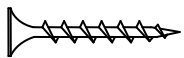
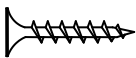
HARDWARE LIST

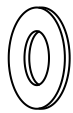
When unpacking, please be careful not to discard any parts with the packaging. Before continuing, please make sure you have all of the following hardware:

NO	Description	Qty	Sketch	NO	Description	Qty	Sketch
1	Short bolt (M6 x 35mm)	2		2	Long bolt (M6 x 60mm)	8	
3	Long screw (M4 x 50mm)	4		4	Short screw (M4 x 35mm)	4	
5	Lock Washer (Ø6.5 x 11mm)	10		6	Flat Washer (Ø6.5 x 19mm)	10	
7	Allen Key (M4 x 30mm x 110mm)	1					

STEP 1

Attach seat frame (B) to the back (A) with bolts (2), and washers (5) and (6) as shown below. Tighten with Allen key (7).

Attach side stretcher (E) to the back (A) with bolts (1), and washers (5) and (6) as shown below. Tighten with Allen key (7).

Note: DO NOT tighten any of the bolts, until the stool is assembled, then put on a flat level surface to make sure the stool is level and then tighten the bolts.

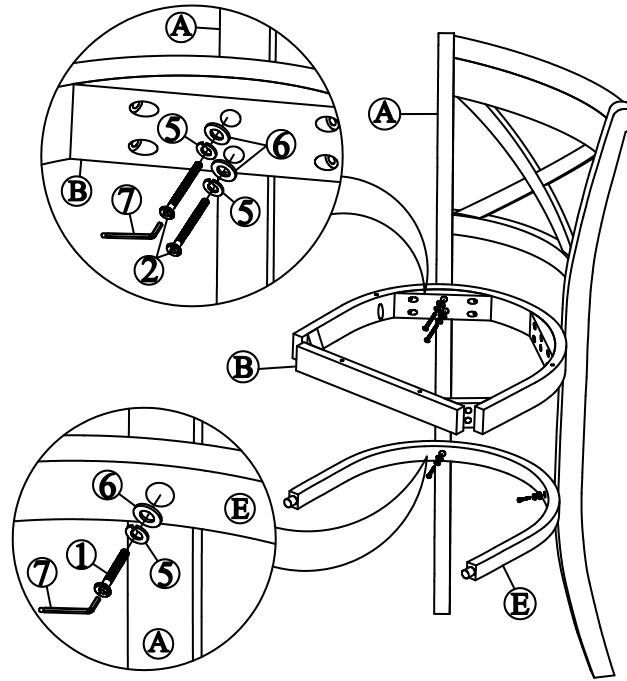

STEP 2

Attach front legs (D) to the seat frame (B) with bolts (2), and washers (5) and (6) as shown below. Tighten with Allen key (7).

Attach side stretcher (E) and front stretcher (F) to front legs with screws (3) as shown below. Tighten with a screwdriver.

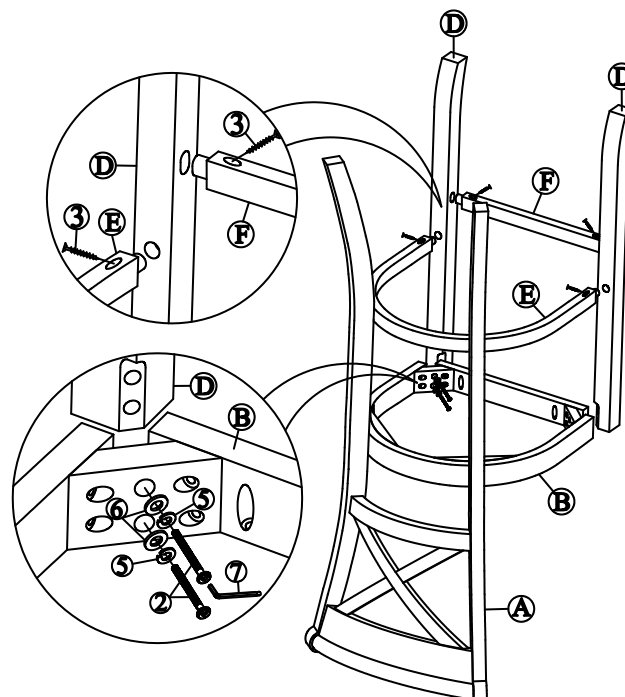

STEP 3

Attach the seat (C) to top of the seat frame (B) with screws (4), as shown below. Tighten with a screwdriver.

