

ASSEMBLY INSTRUCTIONS

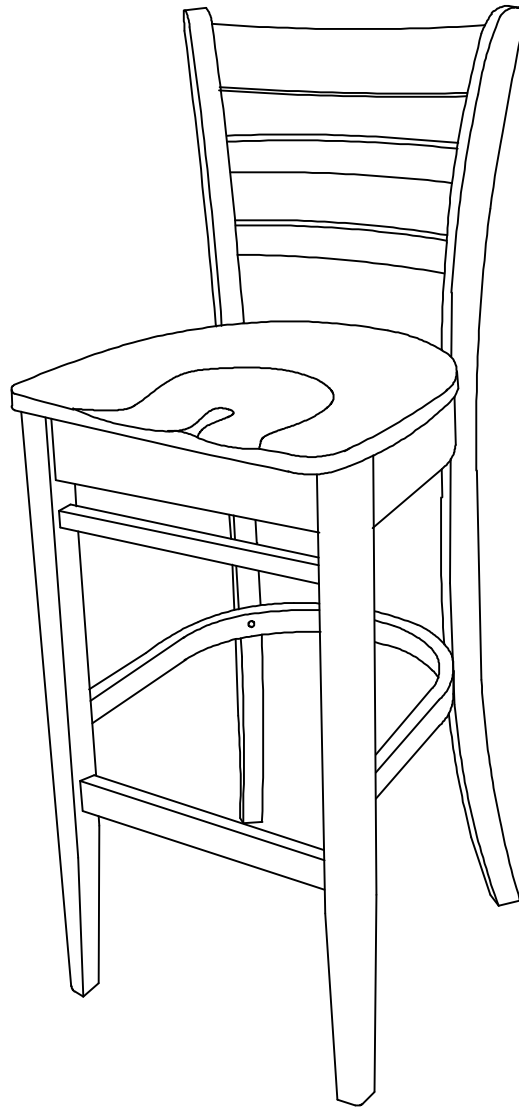

Description : 30 IN EMILY STOOL RTA
Item No. : S-6173

BEFORE ASSEMBLY

Thank you for purchasing this quality product. This product has been designed for easy assembly and constructed for durability. Please take the time to read and follow the assembly instructions carefully.

Be sure to check all packing material carefully for small parts which may have come loose inside the carton during shipment. Please separate, identify, and count all parts and metal hardware. Compare with part list to be sure all parts are present.

If hardware is missing or you have difficulty assembling this product, please call Toll Free: 1-888-944-8396.

IMPORTANT NOTE:

- Place all wooden parts on a clean and smooth surface such as a rug or carpet to avoid the parts from being scratched.
- Remove all wrapping material, including staples & packing straps before you start to assemble.
- DO NOT tighten all screws and bolts until completely assembled.
- Keep all hardware parts out of reach of children.





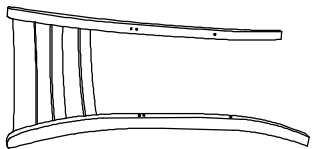
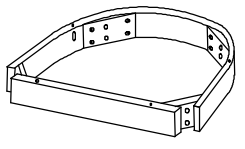
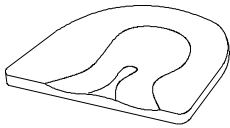
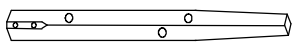
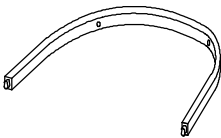
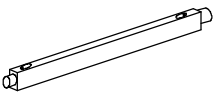
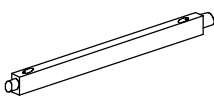

PART LIST

When unpacking, please carefully not to discard any parts with the packaging. Before continuing, please make sure you have all of the following parts:

NO	Description	Qty	Sketch	NO	Description	Qty	Sketch
A	Chair back	1		B	Seat Frame	1	
C	Chair Seat	1		D	Front Leg (L-R)	2	
E	Side Stretcher			F	Front Stretcher (lower)	1	
G	Front Stretcher (upper)	1					

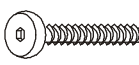
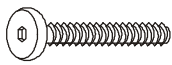
HARDWARE LIST

When unpacking, please carefully not to discard any parts with the packaging. Before continuing, please make sure you have all of the following hardware:

NO	Description	Qty	Sketch	NO	Description	Qty	Sketch
1	Short bolt (M6 x 35mm)	2		2	Long bolt (M6 x 60mm)	8	
3	Screw (M4 x 35mm)	10		4	Lock Washer (Ø6.5 x 11mm)	10	
5	Flat Washer (Ø6.5 x 19mm)	10		6	Allen Key (4x80mm)	1	

STEP 1

Attach seat frame (B) to the back (A) by using bolts (2), washers (4) and (5), as shown below . Tighten with Allen key (6).

Attach Side Stretcher (E) to the back (A) by using bolts (1), washers (4) and (5), as shown below. Tighten with Allen key (6).

Note: DO NOT tighten any of the bolts, until the stool is assembled, then put on a flat level surface to make sure the chair is level and then tighten the bolts.

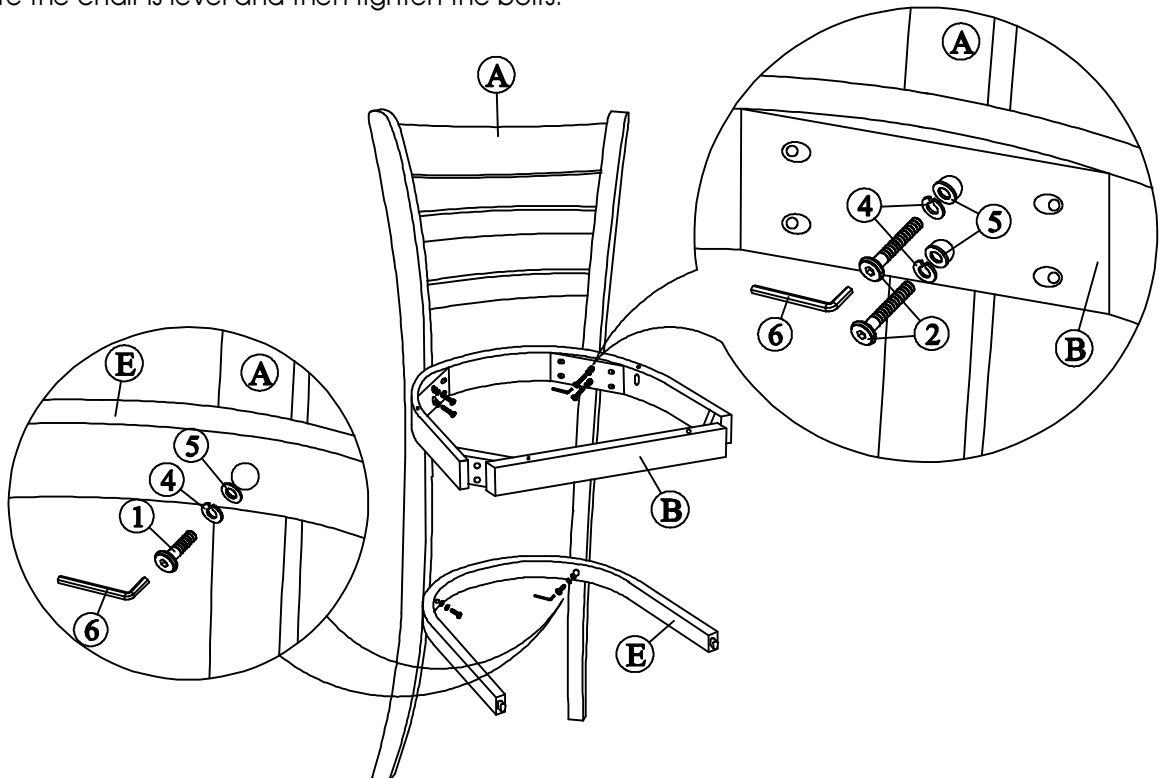

STEP 2

Attach Front Legs (D) to the seat frame with bolts (2), Washers (4) and (5), as shown below. Tighten with Allen Key (6).

Place Side Stretcher (E) and Front Stretcher (F) and (G) between front legs, attach with Screws (3) as shown below. Tighten with a screwdriver.

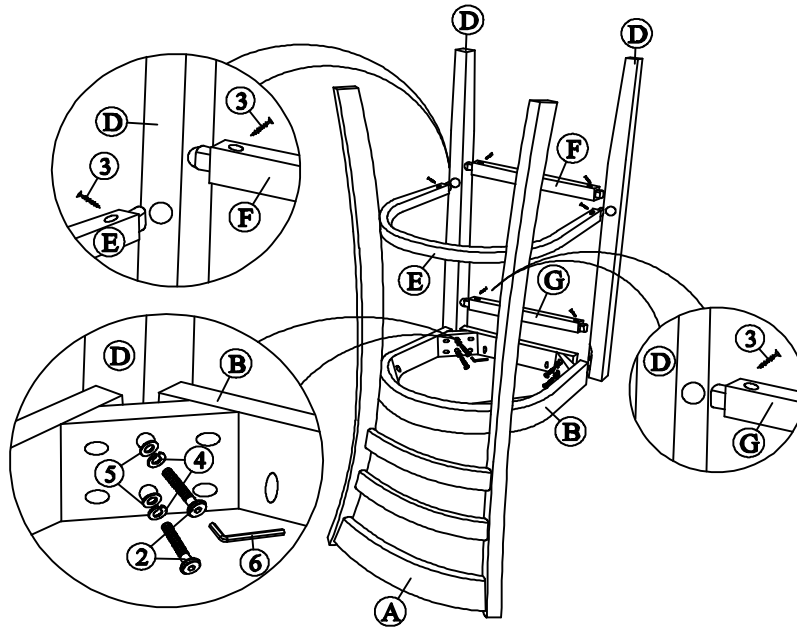

STEP 3

Attach the seat (C) to top of the seat frame (B) with screws (3), as shown below. Tighten with a screwdriver.

