

Addison Panel Storage Beds

DUET = Natural finish

Assembly Instructions

Model #

1995DUET

Addison Full Panel Storage Bed

2018DUET

Addison Queen Panel Storage Bed

2022DUET

Addison King Panel Storage Bed

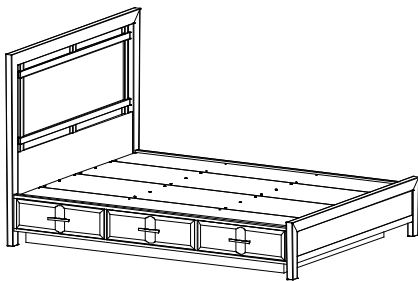

Thank you for allowing us to help you furnish your home. We are certain you will be delighted with your new furniture for many years to come.

IMPORTANT NOTES:

- For normal household use only. *Not* recommended for commercial use.
- Remove items before you move this unit.
- Do not overload the drawers.
- This assembly requires two people.

⚠ WARNING

Drilling, sawing, sanding or machining wood products can expose you to wood dust, a substance known to the state of California to cause cancer. Avoid inhaling wood dust or use a dust mask or other safeguards for personal protection.

For more information go to: www.p65warnings.ca.gov/wood

This product can expose you to chemicals, including formaldehyde, which are known to the State of California to cause cancer.

For more information go to: www.p65warnings.ca.gov/furniture

DESIGN SUBJECT TO CHANGE WITHOUT NOTICE.

CUSTOMER SERVICE

If you ever have questions about your furniture, please do not hesitate to contact us. In the unlikely event you need a replacement part; we can make those parts available through an authorized Whittier Wood Furniture dealer. If you cannot order replacement parts through your dealer, please contact our customer service department.

Hours: Our friendly customer service staff can be reached:

Monday-Friday 8:00 a.m. to 5:00 p.m. (Pacific Time).

You may leave a message 24 hours a day, seven days a week.

Customer Service: 800-653-3336 • Outside the U.S.: 541-687-0213

Fax: 541-687-2060 • Email: info@whittierwood.com

**Whittier
Wood**
FURNITURE

P.O. Box 2827
Eugene, OR 97402 USA

Production Code:

VN





12/17

1995DUET Addison Full Panel Storage Bed
2018DUET Addison Queen Panel Storage Bed
2022DUET Addison King Panel Storage Bed
Parts List

Please note this Assembly Instruction is for all three beds. Please identify the bed part number when ordering parts.

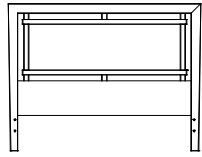
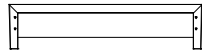
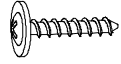
Please identify the parts and check that quantities received match those on this list.
 If you need to replace a part, refer to the following letter and part name.

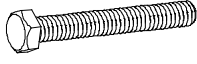





1997DUET
Full Addison Panel Headboard/Footboard Kit (x1)
2020DUET
Queen Addison Panel Headboard/Footboard Kit (x1)

Part	Description		Quantity
A	Headboard Assembly		1
B	Footboard Assembly		1
K	#8 x 7/8" Black Lo-Profile Screw (inserted)		9
L	#8 x 1-1/4" Black Screw		24
Y	5/16" x 14mm Insert Nut (inserted)		8
ZE	5/16" x 2-1/4" Hex Bolt		6
ZF	5/16" x 35mm Hex Bolt		18
ZG	1/4" Flat Washer		24

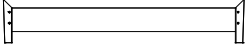
1995DUET Addison Full Panel Storage Bed
2018DUET Addison Queen Panel Storage Bed
2022DUET Addison King Panel Storage Bed
Parts List



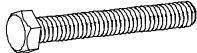
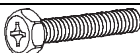





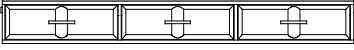
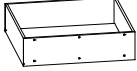
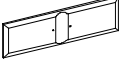

2023DUET

King Addison Panel Headboard/Footboard Kit (x1)

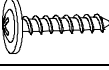
Part	Description	Quantity
A	Headboard Assembly 	1
B	Footboard Assembly 	1
C	Center Deckboard 	1
K	#8 x 7/8" Black Lo-Profile Screw (inserted) 	9
L	#8 x 1-1/4" Black Screw 	36
Y	5/16" x 14mm Insert Nut (inserted) 	8
ZE	5/16" x 2-1/4" Hex Bolt 	6
ZF	5/16" x 35mm Hex Bolt 	18
ZG	1/4" Flat Washer 	24

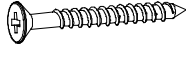





1995DUET Addison Full Panel Storage Bed
2018DUET Addison Queen Panel Storage Bed
2022DUET Addison King Panel Storage Bed
Parts List

1996DUET
Full Pedestal Kit (x2)
2019DUET
Queen/King Pedestal Kit (x2)

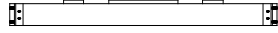
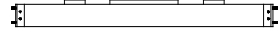
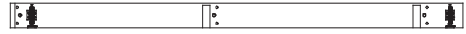
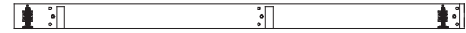
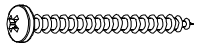







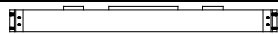

Part	Description	Quantity
D	Pedestal 	1
E	Drawer Box (assembled) 	3
F	Drawer Face (attached) 	3
G	Left/Right Center Deckboard 	1
H	20" Drawer Slides (installed) 	3 sets
I	#6 x 3/4" Philtruss Screw (inserted) 	18
J	#6 x 1/2" Philtruss Screw (inserted) 	18
K	#8 x 7/8" Black Lo-Profile Screw (inserted) 	18
L	#8 x 1-1/4" Black Screw (inserted) 	8
M	#8 x 1-5/8" Black Screw (inserted) 	24
N	#8 x 1-5/8" Machine Screw Tuscan (installed) 	6
O	5/32" x 10mm Insert Nut (inserted) 	6
P	Black Walnut Pull (attached) 	3

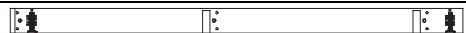
1995DUET Addison Full Panel Storage Bed
2018DUET Addison Queen Panel Storage Bed
2022DUET Addison King Panel Storage Bed
Parts List

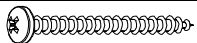
1998DUET Addison Full Base Kit (x1)







Part	Description	Quantity
Q	Mitered End Support 	1
R	Square End Support 	2
S	Left Support 	1
T	Right Support 	1
W	#8 x 1-3/4" Pan Head Screw (inserted) 	12
X	#10 x 3/4" Pan Head Screw (inserted) 	16
Y	5/16" x 14mm Insert Nut (inserted) 	18
ZA	Wood Dowel (inserted) 	12
ZB	Foot Bracket (attached) 	4
ZC	Adjustable Glide (installed) 	4
ZH	Full Trestle Rail (9-1/8") 	4

2021DUET Addison Queen Base Kit (x1)

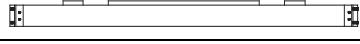
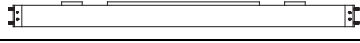
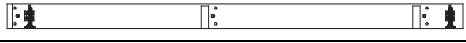
Part	Description	Quantity
Q	Mitered End Support 	1
R	Square End Support 	2
S	Left Support 	1
T	Right Support 	1
U	Queen Trestle Rail (15-1/8") 	4
W	#8 x 1-3/4" Pan Head Screw (inserted) 	12
X	#10 x 3/4" Pan Head Screw (inserted) 	16
Y	5/16" x 14mm Insert Nut (inserted) 	18
ZA	Wood Dowel (inserted) 	12
ZB	Foot Bracket (attached) 	4
ZC	Adjustable Glide (installed) 	4

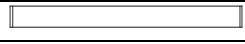
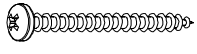
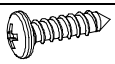
1995DUET Addison Full Panel Storage Bed
2018DUET Addison Queen Panel Storage Bed
2022DUET Addison King Panel Storage Bed
Parts List

2024DUET
Addison King Base Kit (x1)

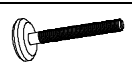
Part	Description	Quantity
Q	Mitered End Support 	1
R	Square End Support 	2
S	Left Support 	1
T	Right Support 	1
V	King Trestle Rail (31-1/4") 	4
W	#8 x 1-3/4" Pan Head Screw (inserted) 	12
X	#10 x 3/4" Pan Head Screw (inserted) 	16
Y	5/16" x 14mm Insert Nut (inserted) 	18
ZA	Wood Dowel (inserted) 	12
ZB	Foot Bracket (attached) 	4
ZC	Adjustable Glide (installed) 	4

1995DUET Addison Full Panel Storage Bed
2018DUET Addison Queen Panel Storage Bed
2022DUET Addison King Panel Storage Bed
Assembly Instructions

This assembly requires two people.

Tools Required: Phillips screwdriver, 7/16" open end or box end wrench.

1. Lay out and identify the parts from the Full (#1998) or Queen (#2021) or King (#2024) Base Kit. Set aside part Trestle Rail (ZH) (Full) or Trestle Rail (U) (Queen) or Trestle Rail (V) (King) for use later in the assembly process. Use the notch and dowels on Square End Support (R) and Mitered End Support (Q) as a guide attach to the Right Support (T) using the Hex Bolts (ZE) and Washers (ZG) from the Headboard/Footboard Kit. See Figures 1 and 1a.

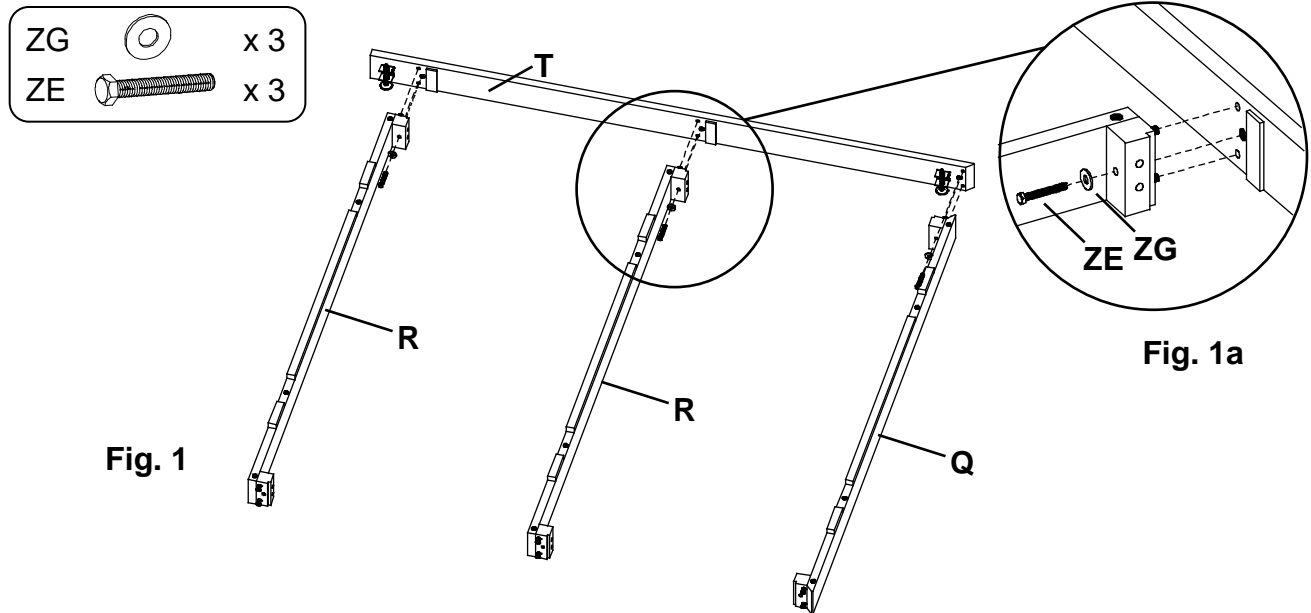

2. Attach the assembly to the Left Support (S) Using Hex Bolts (ZE) and Washers (ZG). See Figures 2 and 2a. Identify the Headboard end of the assembly and place near the final bed location. See drawing below.

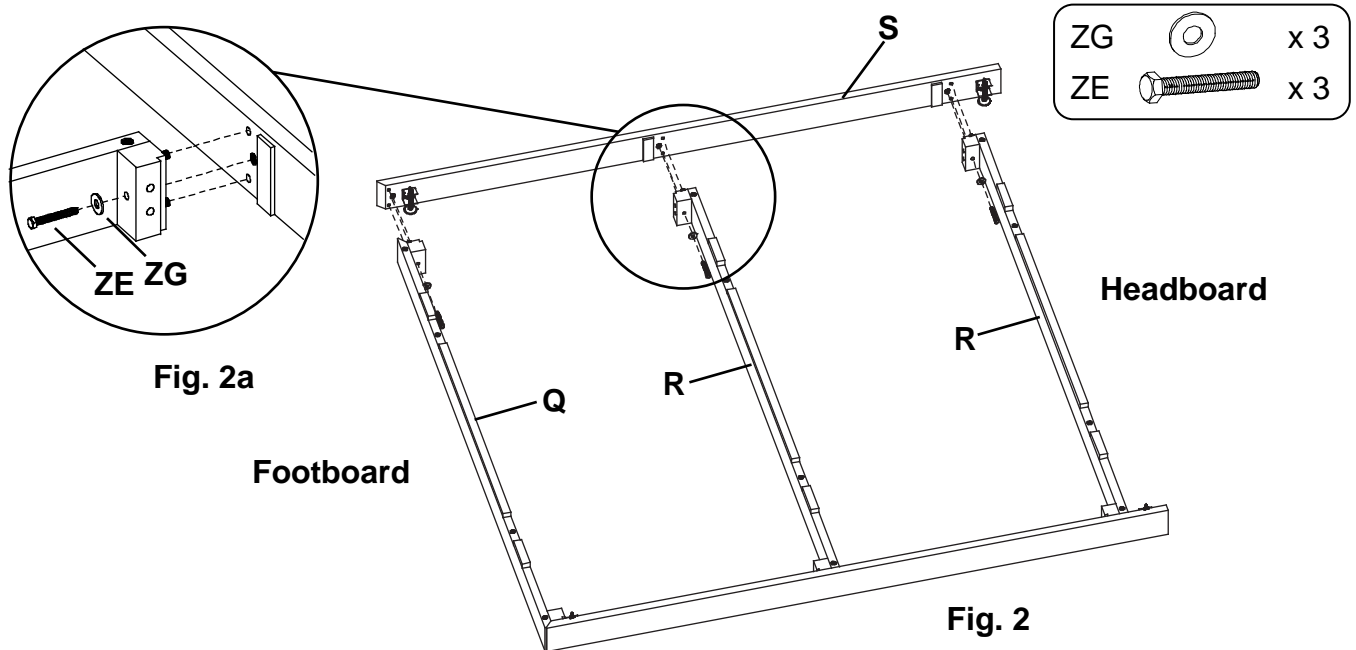

1995DUET Addison Full Panel Storage Bed
2018DUET Addison Queen Panel Storage Bed
2022DUET Addison King Panel Storage Bed

Assembly Instructions

This assembly requires two people.

3. Place each pedestal (D) on top of the base kit against the side of and between the locater blocks of the Base Kit. See Figure 3.

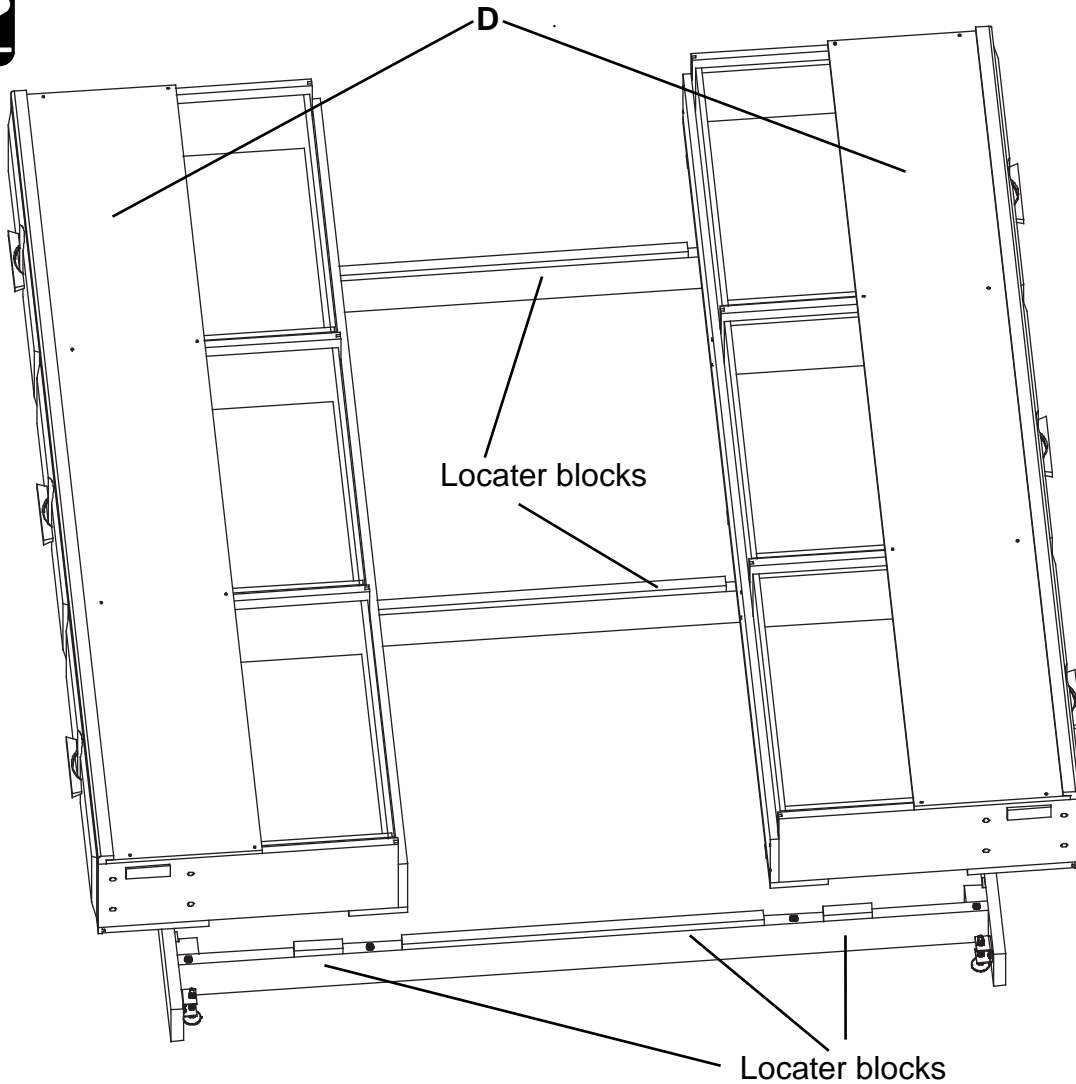

Fig. 3

1995DUET Addison Full Panel Storage Bed
2018DUET Addison Queen Panel Storage Bed
2022DUET Addison King Panel Storage Bed

Assembly Instructions

This assembly requires two people.

4. Open the drawers and attach the pedestal to the base using Hex Bolts (ZF) and Washers (ZG) only finger tight. See Figures 4 and 4a.

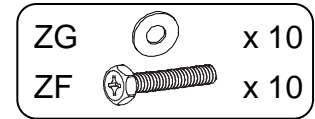
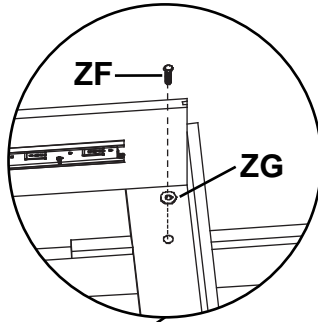

Fig. 4a

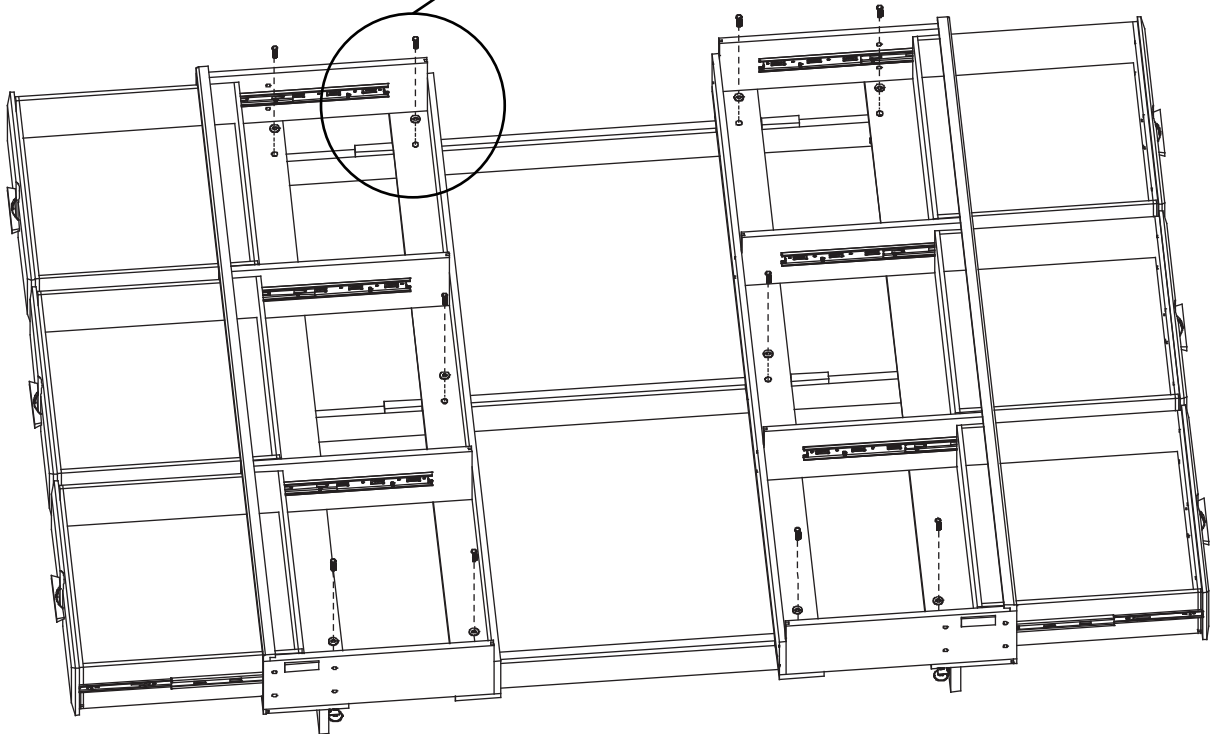

Fig. 4

(Notched Deckboards removed for illustration purposes)

1995DUET Addison Full Panel Storage Bed
2018DUET Addison Queen Panel Storage Bed
2022DUET Addison King Panel Storage Bed



Assembly Instructions

This assembly requires two people.

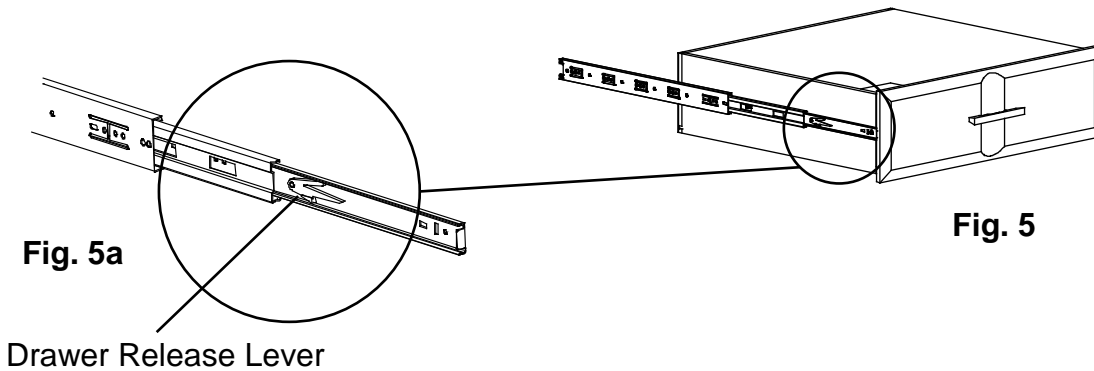
5. There are two options to attach the Footboard (B) to the Pedestal Assembly. Option a) Release the two drawers (E) at the end of the assembly as shown in Fig. 5a. Open the Drawers (E) until the back edge of the drawer is even with the front of the Pedestal. Reach under the attached deckboard from the backside of the pedestal and insert Bolts (ZF) and Washers (ZG) into the Footboard (B). Push the drawers closed. Option b) remove the two end drawers (E) completely. Insert the bolts and washers into the Footboard and reinstall the drawers. See Fig. 5b, 5c.



Option 5b shown in illustration

ZG		x 4
ZF		x 4

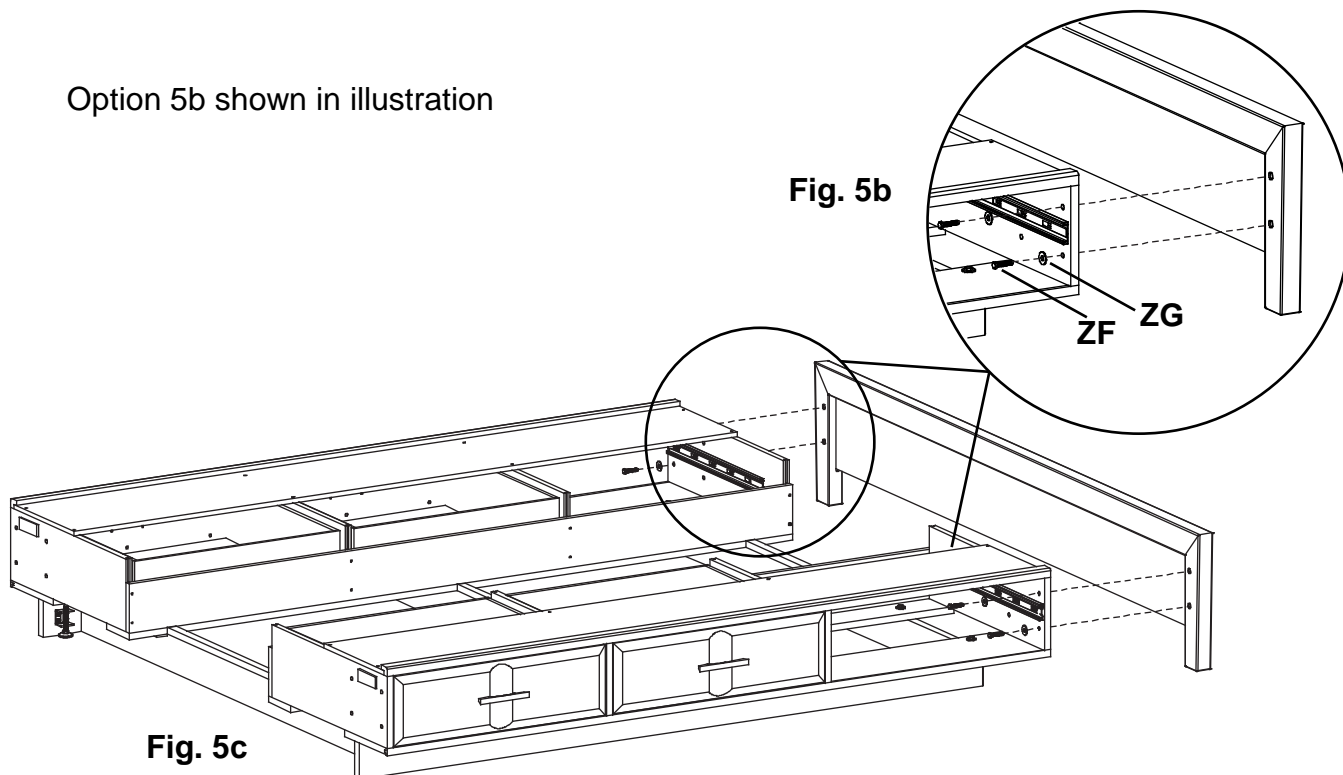

1995DUET Addison Full Panel Storage Bed
2018DUET Addison Queen Panel Storage Bed
2022DUET Addison King Panel Storage Bed
Assembly Instructions

This assembly requires two people.

6. Attach the Headboard (A) with Hex Bolts (ZF) and Washers (ZG) using assembly option a) or b) from Step 5. See Figures 6 and 6a.

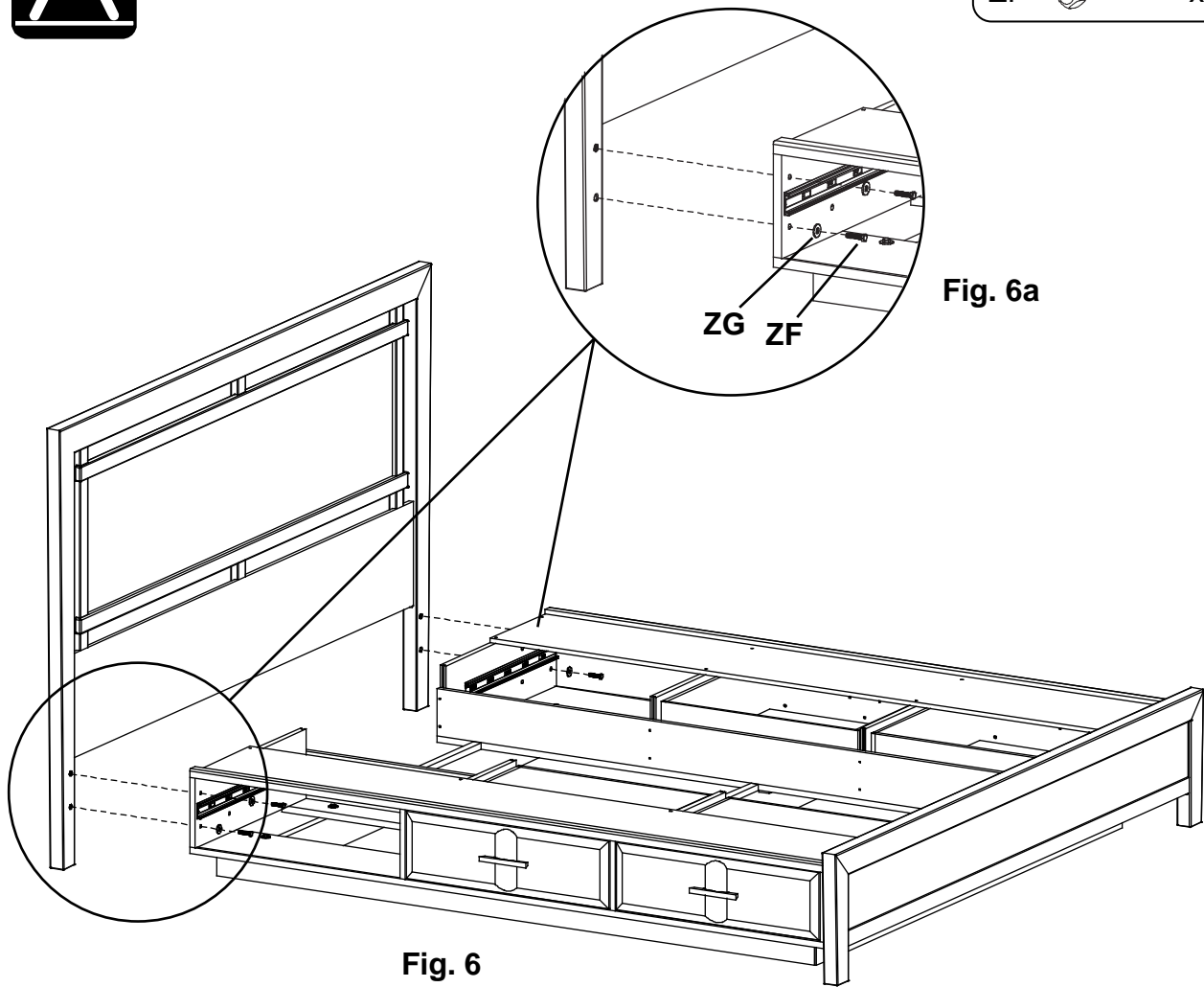
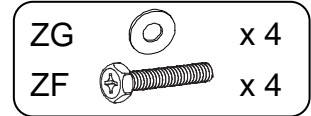

Option 5b shown in illustration

1995DUET Addison Full Panel Storage Bed
2018DUET Addison Queen Panel Storage Bed
2022DUET Addison King Panel Storage Bed

Assembly Instructions

This assembly requires two people.

7. Once the Headboard and Footboard are attached, open all drawers and tighten Hex Bolts (ZF) and Washers (ZG) on the inside of the bed assembly.
8. Adjust levelers (ZC) only if floor is uneven or if bed has movement . See Figures 8 and 8a.

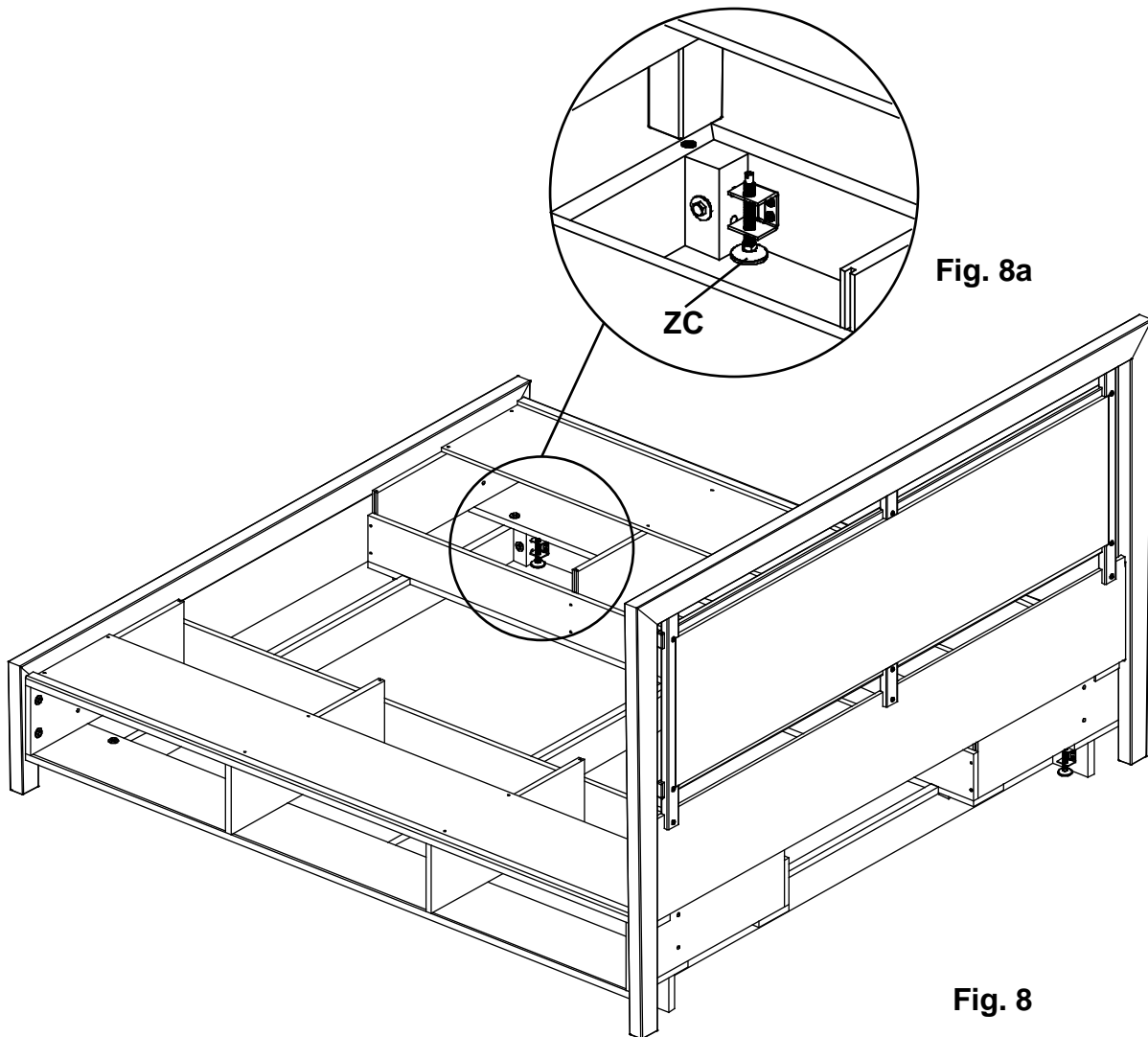

(Drawers and Bottom Boards removed for illustration purposes)

1995DUET Addison Full Panel Storage Bed
2018DUET Addison Queen Panel Storage Bed
2022DUET Addison King Panel Storage Bed
Assembly Instructions

This assembly requires two people.

9. Insert Full Trestle Rail Supports (ZH) or Queen Trestle Rail Supports (U) or King Trestle Rail Supports (V). See Figures 9 and 9a.

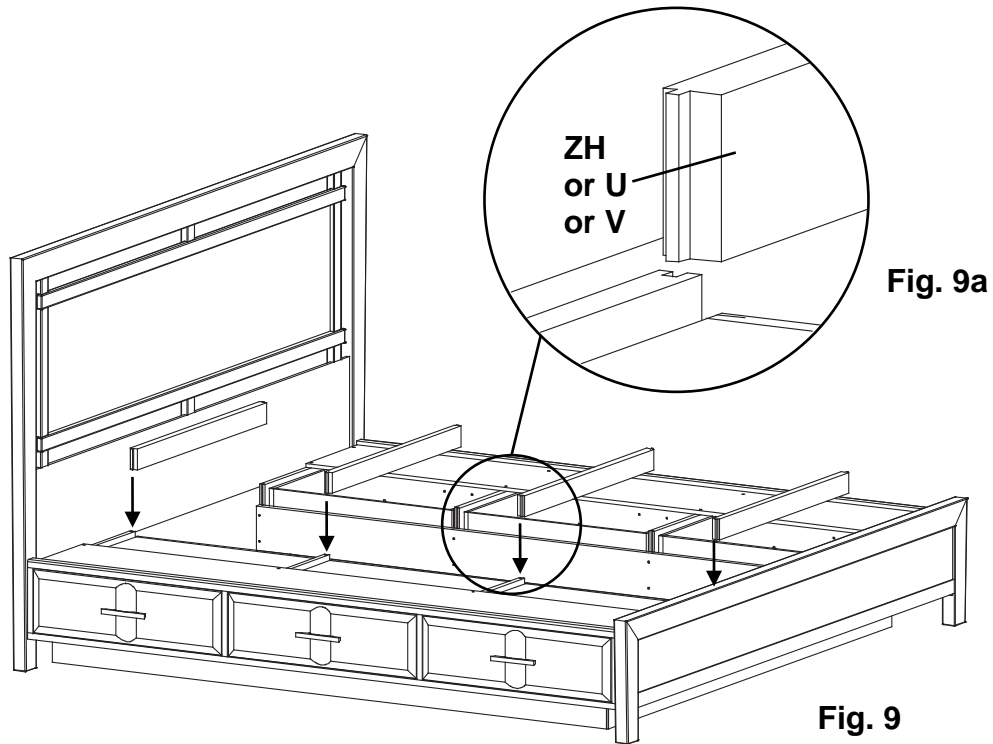

10. Place the Left/Right Center Deckboards (G) as shown in Figure 11 and secure with twelve #8x1-1/4" Black Screws (L). There should be a small gap between each deckboard. See Figure 10.

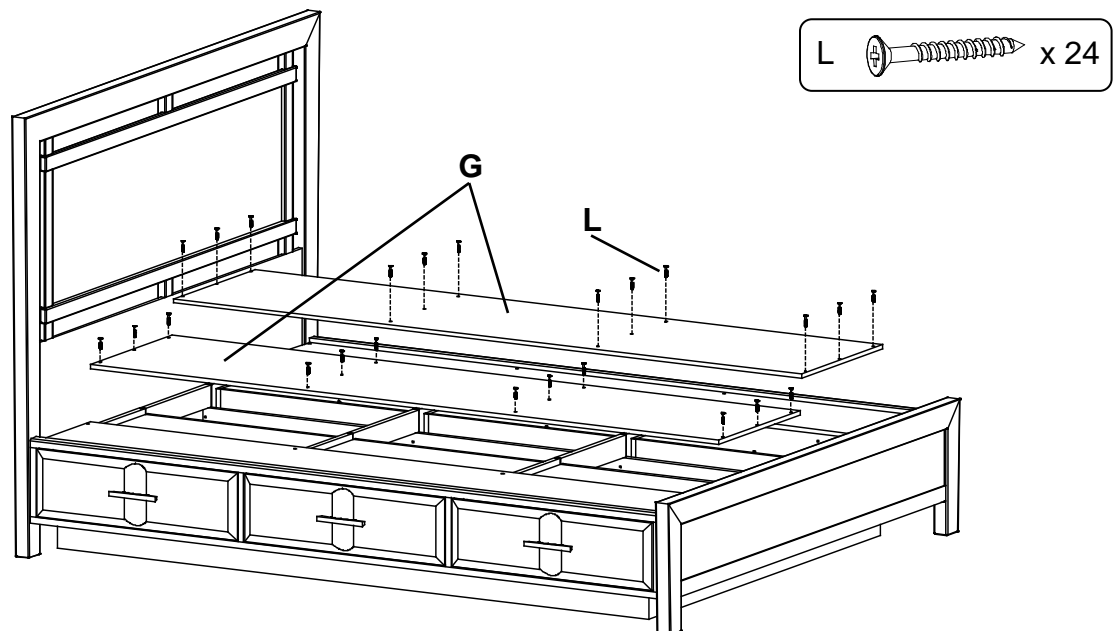

1995DUET Addison Full Panel Storage Bed
2018DUET Addison Queen Panel Storage Bed
2022DUET Addison King Panel Storage Bed

Assembly Instructions

This assembly requires two people.

Step 11 is for the Addison King Panel Storage Bed (#2022)

11. Place the Center Deckboard (C) as shown in Figure 11 and secure with twelve #8 x 1-1/4" Black Screws (L). If you need to adjust the center feet, remove the Center Deckboard, adjust the glides and reattach the deckboard.

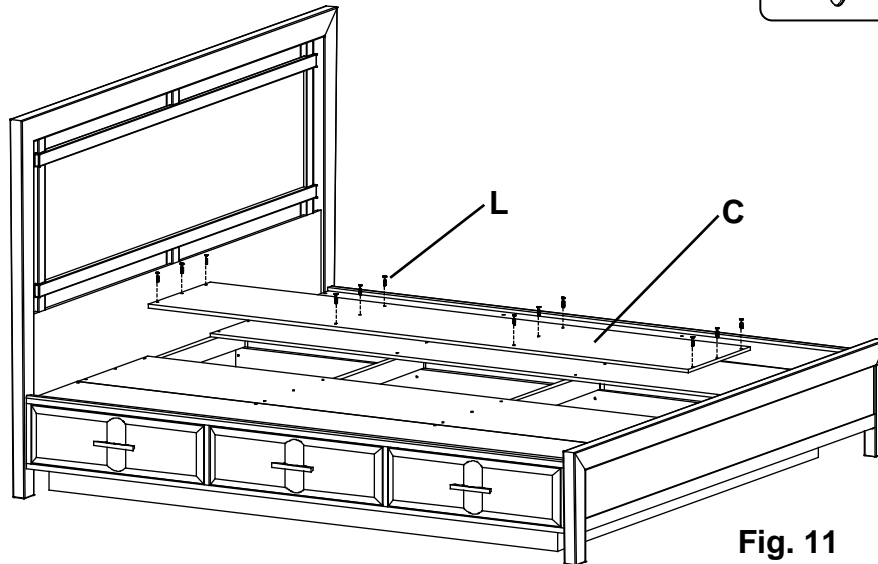
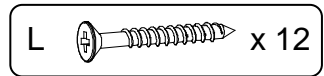

Fig. 11