

ASSEMBLY INSTRUCTIONS

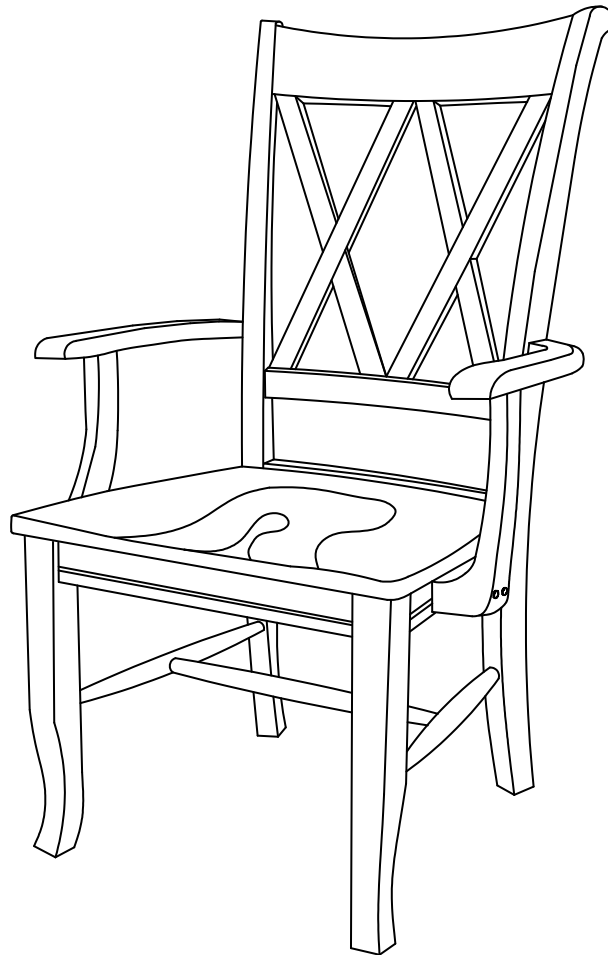

Description : PAIR OF ARMS FOR C-20 CHAIR
Item No. : C-20-ARM

ITEM NO.: C-20-ARM
REVISED OCT 30, 2018

Printed in Vietnam

BEFORE ASSEMBLY

Thank you for purchasing this quality product. This product has been designed for easy assembly and constructed for durability. All parts were checked prior to packaging to insure quality. Prior to beginning assembly, however, make sure all parts and hardware are included and free of obvious defect. If a part is missing or defective, please contact the store where purchased. If hardware is missing, or you need help with assembly, please call toll free 888-944-8396.

IMPORTANT NOTE:

- Place all wooden parts on a clean and smooth surface such as a rug or carpet to avoid the parts from being scratched.
- Remove all wrapping material, including staples & packing straps before you start to assemble.
- DO NOT tighten all screws and bolts until completely assembled.
- Keep all hardware parts out of reach of children.

ASSEMBLY TOOLS REQUIRED

NOT INCLUDED







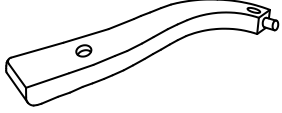

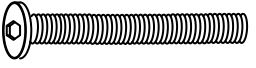

PART LIST

When unpacking, please be careful not to discard any parts with the packaging. Before continuing, please make sure you have the following parts:

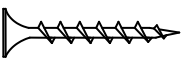
NO	Description	Qty	Sketch	NO	Description	Qty	Sketch
A	Arm support (L-R)	2		B	Arm (L-R)	2	

HARDWARE LIST

When unpacking, please be careful not to discard any parts with the packaging. Before continuing, please make sure you have all of the following hardware:

NO	Description	Qty	Sketch	NO	Description	Qty	Sketch
1	Bolt (M6 x 90mm)	4		2	Lock Washer (Φ6.5 x 11mm)	8	
3	Small Flat Washer (Φ6.5 x 13mm)	4		4	Screw (M4 x 50 mm)	2	
5	Large Flat Washer (Φ6.5 x 19mm)	4		6	Hexagon nut (M6 x 10mm)	4	
7	Allen Key (M4 x 30mm x 110mm)	1		8	Wrench (M10 mm)	1	
9	Wood plug (Φ14.5)	4					

STEP 1

Insert arm supports (A) into arms (B) as shown below.

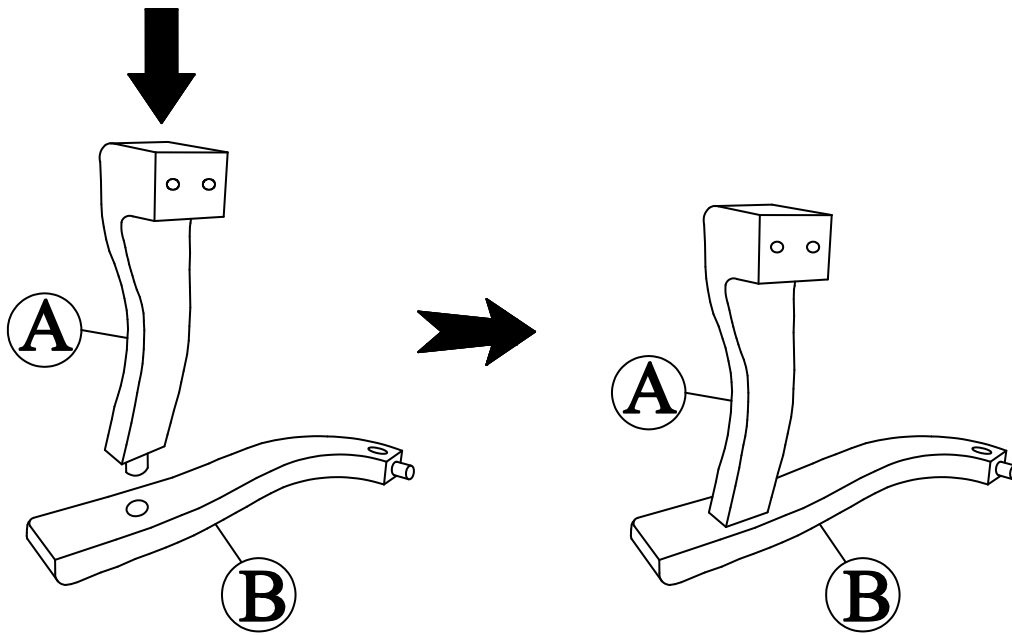

STEP 2

Attach arm supports (A) to seat frame with bolts (1), and washers (2) and (3) as shown below. Tighten with the Allen key (7).

Then use nuts (6), and washers (2) and (5) as shown below. Tighten with wrench (8).

Attach arms (B) to the chair back with screws (4). Tighten with a screwdriver.

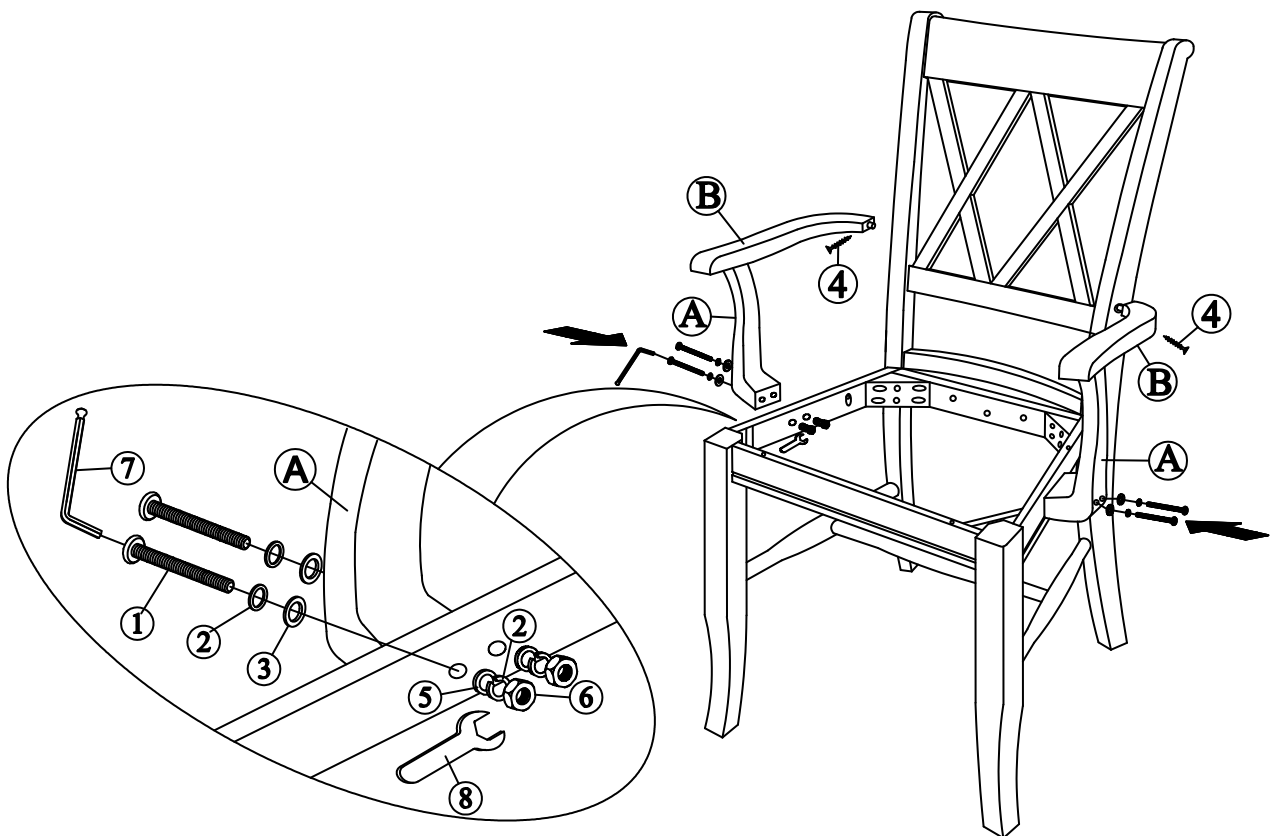

STEP 3

Then insert wood plugs (9) over bolts to cover them.

