

Model #

1508RLN

Bryce Slim Wall Mirror

RLN = Ridgeline finish

Assembly Instructions

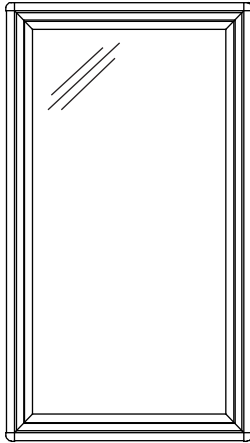

Thank you for allowing us to help you furnish your home. We are certain you will be delighted with your new furniture for many years to come.

IMPORTANT NOTES:

- Wood can be susceptible to changing color over time when exposed to strong sunlight. Use window shades, drapes or blinds to protect your furniture. To help the surface age evenly and avoid dark and light spots, periodically move items to expose the entire surface to an even amount of light so it may develop a uniform patina.
- For normal household use only. *Not* recommended for commercial use.



- Handle the mirror with care. Glass is fragile.
- Before you begin your project, completely read the Assembly Instructions.

WARNING

Drilling, sawing, sanding or machining wood products can expose you to wood dust, a substance known to the state of California to cause cancer. Avoid inhaling wood dust or use a dust mask or other safeguards for personal protection.

For more information go to: www.p65warnings.ca.gov/wood

This product can expose you to chemicals, including formaldehyde, which are known to the State of California to cause cancer.

For more information go to: www.p65warnings.ca.gov/furniture

DESIGN SUBJECT TO CHANGE WITHOUT NOTICE.

CUSTOMER SERVICE

If you ever have questions about your furniture, please do not hesitate to contact us. In the unlikely event you need a replacement part; we can make those parts available through an authorized Whittier Wood Furniture dealer. If you cannot order replacement parts through your dealer, please contact our customer service department.

Hours: Our friendly customer service staff can be reached:

Monday-Friday 8:00 a.m. to 5:00 p.m. (Pacific Time).

You may leave a message 24 hours a day, seven days a week.

Customer Service: 800-653-3336 • **Outside the U.S.:** 541-687-0213

Fax: 541-687-2060 • **Email:** info@whittierwood.com

**Whittier
Wood**
FURNITURE

P.O. Box 2827
Eugene, OR 97402 USA

Production Code:





VN

10/19

1508RLN Bryce Slim Wall Mirror

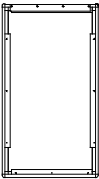
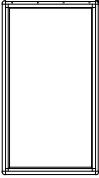
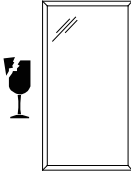
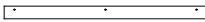
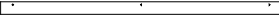
Parts List

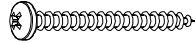
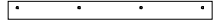
Please identify the parts and check that quantities received match those on this list.
If you need to replace a part, refer to the following letter and part name.

Part	Description	Quantity
A	Mirror Assembly 	1
B	Mirror Frame 	1
C	Mirror (attached) 	1
D	Short Mirror Retainer (attached) 	2
E	Long Mirror Retainer (attached) 	2
F	#6 x 3/4" Brass Flat Head Screw (inserted) 	4
G	#6 x 5/8" Philtruss Screw (inserted) 	12
H	#8 x 1-3/4" Pan Head Screw 	2
I	Mirror Frame Bracket (attached) 	1
J	Mirror Wall Bracket 	1

1508RLN Bryce Slim Wall Mirror

Assembly Instructions

Tools Required: Phillips Screwdriver, Tape Measure, Pencil

1. Determine where you want the bottom of your mirror to end and draw a faint pencil line on the wall. Use a tape measure and measure up $41\text{-}5/8"$ from that mark. Draw a faint line. The top line is where you attach the Mirror Wall Bracket (J). If you like, you can erase the faint bottom pencil mark. See Figure 1.

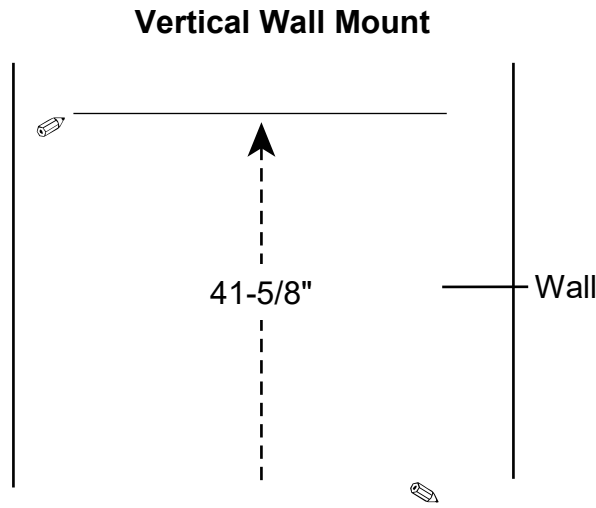
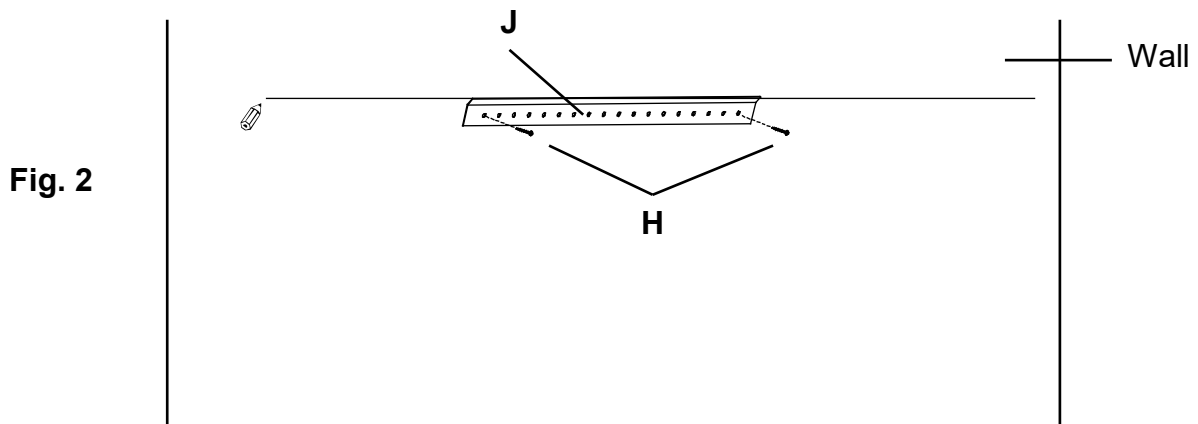
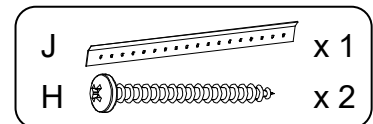

Fig. 1

2. Locate two studs in the wall behind the space where you want to hang your Mirror. Affix the Mirror Wall Bracket (J) into the studs with two #8 x 1-3/4" Pan Head Screws (H). If you cannot locate two studs, purchase the proper wall attachment hardware for your type of wall and secure the bracket. See Figure 2.



1508RLN Bryce Slim Wall Mirror

Assembly Instructions

3. NOTE: The Mirror Wall Bracket (J) angles out at the top. When you hang your Mirror, the Mirror Frame Bracket (I) fits over the angled part of the Mirror Wall Bracket (J). See Figure 3.

